

HO

1:87

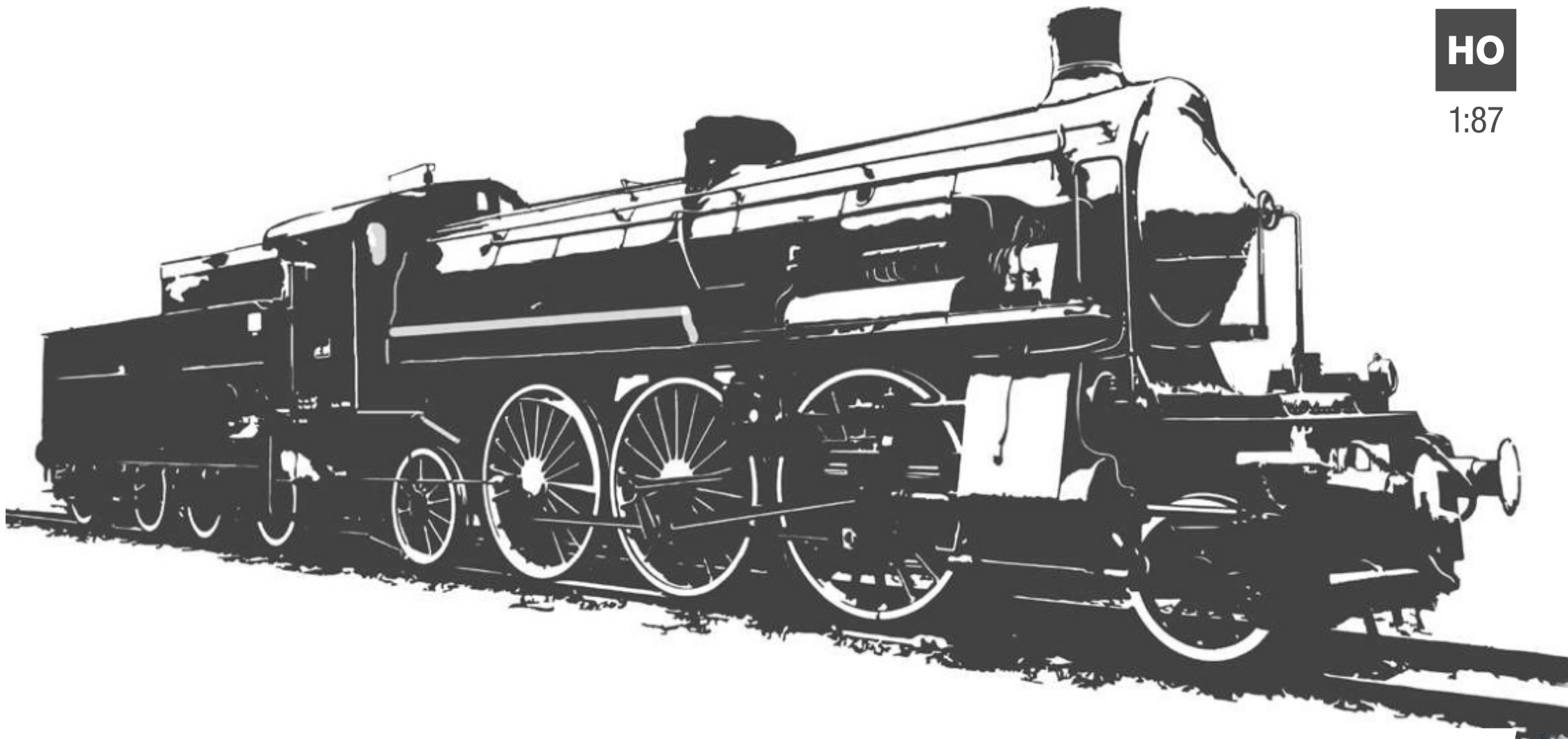

Jouef

 **Rivarossi**

Electrotren

 **Lima**

2025

INDEX

Inhaltsverzeichnis • Index • Indice • Índice

Clubs	4
Shows & Fairs	5
Jouef	8
Jouef Loisirs	58
MKD	64
Electrotren	66
Electrotren Hobby	102
Rivarossi	108
Lima Expert	189
Diorama accessories	198
Heico Modell	204
Spare parts	206
Hornby accessories	208
HM decoders	213
Main index	220
Still available index	224

CLUBS for every fan's passion

Rivarossi
C L U B



FS, bagagliaio UIC-X 1970, senza carenature,
allestimento speciale per esposizioni, ep. IV
Modello esclusivo 2025 riservato ai membri

Alcuni vantaggi di essere parte del Club

Promozioni dedicate fino al 70% di sconto sul sito Rivarossi
Voucher d'acquisto online e sconti fedeltà

Carrozza esclusiva in scala H0
E-ticket di 3 giorni per l'Hobby Model Expo (Novegro)
Tessera personalizzata con numero progressivo
Catalogo 2025 completo dei modelli in scala H0
Anteprime esclusive
Gadget collezionabili imperdibili

www.rivarossi.com

CLUB
Electrotren



RENFE, coche cama Bc10-12601, pre-serie,
decoración "Estrella", ép. IV-V
Modelo esclusivo 2025 reservado para socios

Ventajas por ser socio del Club

Promociones en la web de Hornby
(incluso Arnold, Electrotren, Rivarossi, Jouef, Lima)















Coche exclusivo en escala H0
Revista del Club Electrotren
Catálogo de Electrotren (o Arnold como alternativa)

www.clubelectrotren.com

Meet us SHOWS AND FAIRS

2025

* Dates not yet confirmed

FEB	MAR	APR	MAY	JUN	JUL	SEP	OCT	NOV	
 <p>28jan-01feb</p> <p>Nuremberg Toy Fair Nuremberg</p>		 <p>10apr-13apr</p> <p>Intermodellbau Dortmund</p>					 <p>03oct-05oct</p> <p>Modell Hobby Spiel Leipzig</p>	 <p>31oct-02nov</p> <p>Faszination Modellbau Friedrichshafen</p>	 <p>20nov-23nov</p> <p>N-Scale Convention Stuttgart</p>
		 <p>25apr-27apr</p> <p>Modellbaumesse Tulln</p>							
	 <p>08mar-09mar</p> <p>Lleida Expo Tren Lleida</p>		 <p>26may-27may*</p> <p>Martotren Barcelona</p>					 <p>07nov-09nov*</p> <p>ExpoModelTren Madrid</p>	
	 <p>08mar-09mar</p> <p>Model Expo Italy Verona</p>					 <p>26sep-28sep</p> <p>Hobby Model Expo Novogro</p>			
	 <p>15mar-16mar</p> <p>Salon International du Train Miniature Bourges</p>							 <p>01nov-02nov</p> <p>Savoie Modélisme Chambéry</p>	 <p>28nov-30nov</p> <p>Rail Expo Dreux</p>

SYMBOLS

Zeichenerklärung • Symboles • Simboli • Símbolos

DCC DIGITAL Motorized model, with digital DCC decoder
Gleichstrommodell, digital mit DCC-Decoder
Modèle motorisé pour courant continu avec décodeur DCC
Modello motorizzato in corrente continua, con decoder digitale
Modelo motorizado, con decoder digital DCC

DCC SOUND Motorized model, with digital decoder and sound
Gleichstrommodell, digital mit Sound
Modèle motorisé pour courant continu avec décodeur DCC sonorisé
Modello motorizzato in corrente continua, con sound decoder
Modelo motorizado, con decoder digital y sonido

HM DCC HM7000 Bluetooth decoder onboard
Integrierter HM7000-Bluetooth-Decoder
Décodeur Bluetooth HM7000 intégré
Decoder Bluetooth HM7000 integrato
Decoder Bluetooth HM7000 integrado

NEM 662 Digital plug NEM 662 (Next-18)
Digitalschnittstelle NEM 662 (Next-18)
Prise NEM pour décodeur 662 (Next-18)
Presa NEM per decoder 662 (Next-18)
Enchufe para conector digital NEM 662 (Next-18)

NEM 660 Plug for digital decoder, 21-pins
Lok mit 21-Decoder-Schnittstelle
Prise pour décodeur DCC 21 broches
Presa NEM per decoder 21 poli
Enchufe para conector digital 21 pins

NEM 651 Plug for digital decoder, 6-pins
Lok mit 6-Decoder-Schnittstelle
Prise pour décodeur DCC 6 broches
Presa NEM per decoder 6 poli
Enchufe para conector digital 6 pins

E24 Digital plug E24
Digitalschnittstelle E24
Prise pour décodeur E24
Presa per decoder E24
Enchufe para conector digital E24

xxx Overall length in mm
Länge über Puffer in (mm)
Longueur hors tampons (mm)
Lunghezza fuori respingenti (mm)
Longitud entre topes (mm)

L Built-in interior details
Inneneinrichtung eingebaut
Aménagement intérieur
Modello con dettagli interni
Modelo con interiores detallados

Light Built-in interior illumination
Mit eingebauter Innenbeleuchtung
Modèle avec éclairage intérieur
Modello con illuminazione interna
Modelo con iluminación interior

CLS Model with interior lighting and touch control
Modell mit Innenbeleuchtung und Berührungssensor
Modèle avec éclairage intérieur avec commande tactile
Modello con illuminazione interna con controllo tattile
Modelo con iluminación interior y control táctil

K Extending coupling mechanism
Kurzkupplungs-Mechanik eingebaut
Attelages à élévation
Gancio corto con cinematismo a norma NEM
Con mecanismo elástico para enganche corto

Handshake American knuckle coupler
Amerikanische Klauenkupplung
Attelage américain
Enganche americano
Gancio americano

Star Motorised fan
Elektrisch angetriebener Ventilator
Ventilateur motorisé
Ventilador motorizado
Ventilatore motorizzato

Power Power supply can be switched to catenary
Umschaltbar auf Oberleitungsbetrieb
Prise de courant par caténaire fonctionnelle
Alimentazione da linea aerea
Pantógrafa con toma de corriente funcional

Spring Sprung buffers
Federpuffer
Tampons avec ressort
Topes con muelle
Respingenti molleggiati

Plastic Metal die-cast chassis with plastic body shell
Fahrwerk aus Metallspritzguss, Lokomotivgehäuse aus Kunststoff
Châssis métallique avec carrosserie en plastique
Telaio in metallo, corpo in plastica
Chasis metálico con carrocería en plástico

Metal Metal die-cast chassis with metal die-cast body shell
Fahrwerk und Lokomotivgehäuse aus Metallspritzguss
Châssis et carrosserie en métal
Telaio in metallo, corpo in metallo
Chasis y carrocería en metal

Motor Motor with flywheel
Motor mit Schwunghasse
Moteur avec volant d'inertie
Motore con volano
Motor con volante de inercia

Cabin Detailed cabin interior
Detaillierter Kabineninnenraum
Intérieur détaillé de la cabine
Interni della cabina dettagliati
Interior detallado de la cabina

Headlights Locomotive with white/red reversing headlights
Spitzen- und Schlussbeleuchtung mit der Fahrtrichtung wechselnd
Éclairage avec inversion blanc/rouge
Locomotiva con luci reversibili bianche e rosse
Locomotora con luces reversibles blancas y rojas

NEW New item from new tooling
Neues Modell aus neuen Formen
Nouveau modèle de nouveaux outillages
Nuovo modello da nuovi stampi
Nuevo modelo de nuevos moldes

NEW New item with tooling modification
Neues Modell mit Werkzeugänderungen
Nouveau modèle avec modifications d'outillage
Nuovo modello con modifiche di stampo
Nuevo modelo con modificaciones de moldes

NEW New item 2025
Neues Modell 2025
Nouveau modèle 2025
Nuovo modello 2025
Nuevo modelo 2025

PERIOD

Epoche • Époque • Epoca • Época

I Period / Epoche / Époque / Época / Epoca I: 1848 - 1920

II Period / Epoche / Époque / Época / Epoca II: 1921 - 1940

III Period / Epoche / Époque / Época / Epoca III: 1941 - 1970

IV Period / Epoche / Époque / Época / Epoca IV: 1971 - 1990

V Period / Epoche / Époque / Época / Epoca V: 1991 - 2006

VI Period / Epoche / Époque / Época / Epoca VI: 2007 -

SCALE

Maßstab • Échelle • Scala • Escala

HO 1:87

Tutti i diritti sui loghi FS, Frecciarossa, Frecciabianca e Frecciargento sono di proprietà di Ferrovie dello Stato Italiane S.p.A. e Trenitalia S.p.A.

International Catalogue 2025

English

Dear Model Railway Enthusiasts,
Are you ready to discover a world
in scale?

We are excited to present our new
2025 Catalog!
What awaits you?

- Exclusive models: impeccable details, historical accuracy, and technical innovation.
- Unmissable novelties: limited editions you won't want to miss.
- Products from around the globe: an international selection to inspire every enthusiast, wherever you are.
- Unique accessories: complete your layouts with extraordinary elements.

We know that every detail matters. That's why our catalog has been designed to delight both experienced collectors and newcomers alike, with a special focus on quality and variety.

Because model railroading isn't just a hobby—it's a lifelong passion!

Deutsch

*Liebe Modellbahn-Enthusiasten,
Bereit, eine Welt im Maßstab zu
entdecken?*

*Wir freuen uns, Ihnen unseren
neuen Katalog 2025 vorstellen zu
können!
Was erwartet Sie?*

- *Exklusive Modelle: makellose Details, historische Genauigkeit und technische Innovation.*
- *Unverzichtbare Neuheiten: limitierte Editionen, die Sie nicht verpassen dürfen.*
- *Produkte aus aller Welt: eine internationale Auswahl, die jeden Liebhaber inspiriert, egal wo Sie sich befinden.*
- *Einzigartige Zubehörteile: vervollständigen Sie Ihre Szenen mit außergewöhnlichen Elementen.*

Wir wissen, dass jedes Detail zählt. Deshalb wurde unser Katalog entwickelt, um sowohl erfahrene Sammler als auch Neueinsteiger zu begeistern, mit besonderem Augenmerk auf Qualität und Vielfalt.

Denn Modelleisenbahnen sind nicht nur ein Hobby, sie sind eine Leidenschaft fürs Leben!

Français

*Chers passionnés de modélisme
ferroviaire,
Prêts à découvrir un monde à
l'échelle ?*

*Nous sommes ravis de vous
présenter notre nouveau Catalogue
2025 !
Qu'est-ce qui vous attend ?*

- *Modèles exclusifs : des détails impeccables, une fidélité historique et une innovation technique.*
- *Nouveautés incontournables : des éditions limitées à ne pas manquer.*
- *Produits du monde entier : une sélection internationale pour inspirer chaque passionné, où que vous soyez.*
- *Accessoires uniques : complétez vos décors avec des éléments extraordinaires.*

Nous savons que chaque détail compte. C'est pourquoi notre catalogue a été conçu pour séduire aussi bien les collectionneurs expérimentés que les nouveaux passionnés, avec un soin particulier porté à la qualité et à la diversité des propositions.

Parce que le modélisme ferroviaire n'est pas qu'un hobby, c'est une passion pour la vie !

Italiano

*Caro fermodellisti,
Pronti a scoprire un mondo in
scala?*

*Siamo entusiasti di presentare il
nostro nuovo Catalogo 2025!
Cosa vi attende?*

- *Modelli esclusivi: dettagli impeccabili, fedeltà storica e innovazione tecnica.*
- *Novità imperdibili: edizioni limitate che non puoi lasciarti scappare.*
- *Prodotti da tutto il mondo: una selezione internazionale per ispirare ogni appassionato, ovunque si trovi.*
- *Accessori unici: completa i tuoi scenari con elementi straordinari.*

Sappiamo che ogni dettaglio conta. Per questo, il nostro catalogo è stato pensato per entusiasmare sia i collezionisti più esperti che i nuovi appassionati, con un occhio di riguardo alla qualità e alla varietà delle proposte.

Perché il fermodellismo non è solo un hobby, è una passione che dura tutta la vita!

Español

*Queridos aficionados al modelismo
ferroviario,
¿Están listos para descubrir un
mundo a escala?*

*Estamos emocionados de presentar
nuestro nuevo Catálogo 2025.
¿Qué les espera?*

- *Modelos exclusivos: detalles impecables, fidelidad histórica e innovación técnica.*
- *Novedades imprescindibles: ediciones limitadas que no querrán perderse.*
- *Productos de todo el mundo: una selección internacional para inspirar a cada aficionado, donde sea que estén.*
- *Accesorios únicos: completa tus escenarios con elementos extraordinarios.*

Sabemos que cada detalle importa. Por eso, nuestro catálogo ha sido diseñado para entusiasmar tanto a los coleccionistas más experimentados como a los recién llegados, con un enfoque especial en la calidad y la variedad.

Porque el modelismo ferroviario no es solo un pasatiempo, ¡es una pasión para toda la vida!



Photo: Quentin de Monleon

Index • Index

Locomotives à vapeur.....10

Steam locomotives.....10

Locomotives diesel.....12

Diesel locomotives.....12

Locomotives électriques.....20

Electric locomotives.....21

Voitures.....24

Coaches.....24

Wagons.....30

Wagons.....30

Arrivées récentes.....46

Still available.....46



www.jouef.com

Jouef®

Jouef est fier de vous présenter le tout nouveau catalogue 2025, riche en grandes nouveautés tant attendues et enfin disponibles ! Chaque passionné de modélisme ferroviaire trouvera le train de ses rêves avec Jouef !

La diversité de nos trains vous permettra d'enrichir votre collection et de vivre pleinement votre passion avec un choix parmi , des locomotives électriques, des locomotives diesel et à vapeur. Des wagons de marchandises et des voitures voyageurs.

Enfin disponibles, les RGP I déjà annoncées fin de l'année dernière, ainsi que la locomotive à vapeur 040 D du Dépôt de Calais. Pour étoffer encore notre gamme, de nouvelles locomotives électriques du type BB et CC, de nouvelles versions de la Vossloh DE 18, ainsi que la toute nouvelle série de voitures TEE "Jules Verne", pour la première fois équipées de decodeurs HM. Et ne manquez pas notre grande sélection de nouveaux wagons, de tous types, avec des livrées emblématiques et captivantes.



040 D

Jouef archive

Ces locomotives appartiennent au type G 8.1 des Chemins de fer royaux prussiens (KPEV), construits en Allemagne entre 1913 et 1921, à plus de 5.000 exemplaires. Après l'armistice de 1918, plus de 1.500 locomotives furent transférées vers la Belgique, la Pologne et la France.

En France, l'administration Alsace-Lorraine, Compagnie de l'Est, Compagnie du Nord, ETAT, Paris-Orléans, MIDI et PLM ont reçu un grand nombre de ces machines. Cependant dès 1946, seule deux régions, l'Est et le Nord, utilisaient encore ces locomotives pour le trafic marchandise.

La 1-040 D 260 SNCF (ex G8.1 5260 Alsace-Lorraine) fut la dernière locomotive en service jusqu'à sa radiation le 01 juillet 1966. Ces locomotives disposaient d'un tender à 3 essieux d'une capacité de 16,5 m³ d'eau et de 7 tonnes de charbon, une puissance de 934 kW et une vitesse maximale de 50 km/h.

HJ2417/HJ2417S

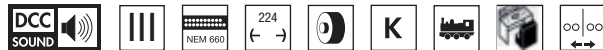

NEW

-  **SNCF, locomotive à vapeur 2-040 D 65, dépôt de Calais**
- SNCF, Schlepptenderdampflokomotive 2-040 D 65, Depot Calais
- SNCF, locomotiva a vapore 2-040 D 65, deposito di Calais
- SNCF, locomotora de vapor 2-040 D 65, depósito de Calais
- SNCF, steam locomotive with tender 2-040D 65, depot Calais



Réservoir à T.I.A sur le tender



- Avec boîte à feu scintillant
- Mit flackerner Feuerbüchse
- Con forno scoppiettante
- Con luz en la caja de fuegos
- With flickering firebox



Modification d'outillage pour HJ2417/S:

- Nouvelle porte de boîte à fumée
- Nouveaux feux avant
- Nouveaux détails sous la cabine
- Nouveaux éléments de chaudière
- Nouveaux détails du tender (réservoir à T.I.A)



Les RGP I

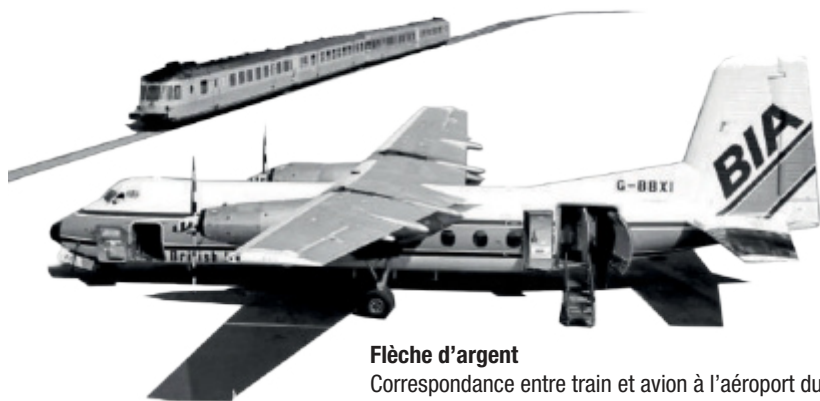

Flèche d'argent

Correspondance entre train et avion à l'aéroport du Touquet dans le cadre de la liaison Paris-Angleterre, 1979.

Les Rames à Grand Parcours

Les **Rames à Grand Parcours (RGP)**, commandées par la SNCF en 1950, ont marqué une avancée dans les services de transport de longue distance. Équipées d'un moteur MGO, ces rames, conçues par De Dietrich pour les motrices et Brissonneau & Lotz pour les remorques, sont nées pour répondre aux besoins de rapidité et de confort des voyageurs sur de grands trajets. Dérivées structurellement des RGP 2 X 2700 et mécaniquement des X 2800, les RGP I se déclinaient en deux versions : une livrée vert et crème pour le service intérieur, et une autre rouge carmin et crème réservée aux prestigieux **Trans Europ Express (TEE)**, dédiée aux trajets internationaux en première classe.

À partir de 1957, les RGP I X 2770 ont pris en charge des lignes TEE emblématiques telles que **L'Arbalète** (Paris-Zurich), **L'Étoile du Nord** (Paris-Bruxelles), et **Le Mont-Cenis**

(Lyon-Turin), assurant ainsi des liaisons de qualité entre la France et ses voisins européens. Après leur retrait du service TEE en **1965**, ces rames ont été affectées à des liaisons transversales de prestige, comme Le Catalan (Genève-Cerbère) et Le Rhodanien (Genève-Marseille), où elles ont continué de transporter des passagers en première classe avec supplément.

Entre **1985 et 1991**, les RGP I ont subi une modernisation : renforcement de la face avant, ajout d'aménagements intérieurs inspirés des Z2, et cabines de conduite modernisées. Leur livrée est alors devenue gris clair, avec des bandeaux de couleur (jaune, bleu, ou rouge) en fonction des régions TER. Ces rames modernisées ont ainsi assuré de nouveaux services régionaux jusqu'à la fin de leur carrière, conservant leur rôle clé dans le réseau ferroviaire français.

HJ2461/HJ2461S



SNCF, autorail diesel RGP I avec remorque, livrée TEE rouge/beige

SNCF, Dieseltriebwagen RGP I mit Beiwagen, rot/beige TEE-Farbgebung

SNCF, automotrice diesel RGP I con rimorchio, livrea TEE rosso/beige

SNCF, automotor diésel RGP I con remolque, decoración TEE rojo/beige

SNCF, diesel railcar RGP I with trailer in red/beige TEE livery

NEW



Le **TEE « Parsifal »** (TEE 155/190) a été lancé le 3 Octobre 1957, établissant une liaison rapide entre **Paris** et **Dortmund**. Ce train prestigieux, qui partait tôt le matin et revenait en soirée, a rapidement gagné en popularité.

En été 1958, il a ajouté des arrêts à Düsseldorf, Duisburg et Bochum, bien que l'arrêt à Herbesthal ait été supprimé, puis rétabli un an plus tard. Avec des rames **RGP I** en rotation quotidienne, le Parsifal incarnait le confort et l'élégance, offrant aux voyageurs une expérience de voyage inégalée à une époque où le train symbolisait le luxe en Europe.



© Jean-Philippe Thernisien

HJ2462/HJ2462S



SNCF, autorail diesel RGP I avec remorque, livrée vert/beige

SNCF, Dieseltriebwagen RGP I mit Beiwagen, grün-beige Farbgebung

SNCF, automotrice diesel RGP I con rimorchio, livrea verde/beige

SNCF, automotor diésel RGP I con remolque, decoración verde/beige

SNCF, diesel railcar RGP I with trailer, green/beige livery



Premiers rendus du modèle non définitifs



© Jean-Philippe Thernisien

NEW

HJ2463/HJ2463S



SNCF, autorail diesel RGP I avec remorque, livrée gris béton « Alpazur »

SNCF, Dieseltriebwagen RGP I mit Beiwagen, gris béton Farbgebung „Alpazur“

SNCF, automotrice diesel RGP I con rimorchio, livrea gris béton “Alpazur”

SNCF, automotor diésel RGP I con remolque, decoración gris béton “Alpazur”

SNCF, diesel railcar RGP I with trailer in gris béton livery “Alpazur”



Premiers rendus du modèle non définitifs



© Jean-Philippe Thernisien

HJ2436/HJ2436S

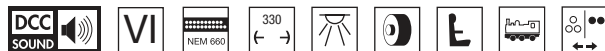

SNCF, autorail diesel classe X 73500 « Imaginalsace »

SNCF, Dieseltriebwagen der Reihe X 73500 in neuer Farbgebung „Imaginalsace“

SNCF, automotrice diesel classe X 73500 “Imaginalsace”

SNCF, automotor diesel X 73500, decoración “Imaginalsace”

SNCF, diesel railcar class X 73500 “Imaginalsace”



Imaginalsace

Imaginalsace est une marque promotionnelle dédiée à la région Alsace, célébrant son patrimoine, sa culture et ses paysages uniques. Le TER X 73551 de la SNCF arbore une livrée spéciale aux couleurs d'Imaginalsace, parcourant les rails avec un design vibrant qui incite à découvrir la richesse de cette région. Ce train devient ainsi un ambassadeur mobile, illustrant l'alliance entre tradition et modernité qui caractérise l'Alsace. Grâce à cette initiative, chaque voyage est une invitation à imaginer l'Alsace et à en explorer ses trésors.

Les points forts

- Édition spéciale limitée
- Interface numérique selon NEM 660 (21MTC)
- Moteur à cinq pôles avec volant d'inertie
- Éclairage avant et arrière avec inversement suivant le sens de marche
- Éclairage intérieur réglable par potentiomètre sur la platine
- Attelages Scharfenberg fonctionnels dans le sachet d'accessoire
- Variante sonore avec son original de l'automoteur.



HJ2437/HJ2437S



SNCF, autorail diesel classe X 73500 « La Région »

SNCF, Dieseltriebwagen der Reihe X 73500 „La Region“

SNCF, automotrice diesel classe X 73500 “La Region”

SNCF, automotor diesel X 73500, decoración “La Region”

SNCF, diesel railcar class X 73500 “La Region”



HJ2438/HJ2438S



SNCF, autorail diesel classe X 73500 « Nouvelle Aquitaine » (Bordeaux)

SNCF, Dieseltriebwagen der Reihe X 73500 „Nouvelle Aquitaine“ (Bordeaux)

SNCF, automotrice diesel classe X 73500 “Nouvelle Aquitaine” (Bordeaux)

SNCF, automotor diesel X 73500, decoración “Nouvelle Aquitaine” (Bordeaux)

SNCF, diesel railcar class X 73500 “Nouvelle Aquitaine” (Bordeaux)



Stores pare soleil
à toutes les fenêtres



HJ2342/HJ2342S



SNCF, locomotive diesel BB 467471 à parois latérales lisses, livrée « FRET »
 SNCF, Diesellokomotive BB 467471 mit flachen Seitenwänden in „FRET“-Farbgebung
 SNCF, locomotiva diesel BB 467471 con pareti laterali lisce, livrea “FRET”
 SNCF, locomotora diésel BB 467471, con paredes laterales lisas, decoración “FRET”
 SNCF, diesel locomotive BB 467471 with flat lateral walls in “FRET” livery



Ventilateurs fonctionnels



Les BB 67400

Les BB 67400 forment une série de locomotives diesel-électriques construites à 232 exemplaires pour la SNCF par Brissonneau et Lotz (BL) et Matériel de traction électrique (MTE). Elles ont été commandées le 6 janvier 1967, et la première a été mise en service le 14 août 1969 au dépôt de Chambéry. On comptait 66 machines en service au 4 octobre 2022 réparties entre CIC, Fret, TER, Infra et la Cellule Matériel Radié (CMR).

Le modèle **JOUEF HJ2342** reproduit la locomotive 467471 en livrée FRET époque VI à faces lisses sans enjoliveurs latéraux ni plaques. Un pare-soleil pour le conducteur, présent dans la cabine n°1, a été intégré au pare brise. Dans la cabine n°1, un conducteur a été ajouté et un pare soleil intégré au pare brise.



Il y a 50 ans, en 1975, Jouef lançait le premier modèle d'une BB 67400 de la SNCF. 50 ans plus tard, nous produisons la troisième génération de modèles de cette série de locomotives bien connue.



HJ2342

HJ6228

HJ6230

HJ6282



HJ2465

HJ4183



HJ2464/HJ2464S



SNCF, locomotive diesel-électrique BB 67613, livrée rouge « Capitoile »

SNCF, 4-achsige dieselelektrische Mehrzwecklokomotive BB 67613 in roter „Capitoile“-Farbgebung

SNCF, locomotiva diesel-elettrica BB 67613, livrea rossa “Capitoile”

SNCF, locomotora diésel BB 67613, decoración rojo “Capitoile”

SNCF, diesel-electric locomotive BB 67613 in red “Capitoile” livery



Figurine du conducteur



HJ2465/HJ2465S



SNCF Infra, locomotive diesel-électrique BB 667548, livrée jaune « INFRA »

SNCF Infra, 4-achsige dieselelektrische Mehrzwecklokomotive BB 667548, gelbe Farbgebung „INFRA“

SNCF Infra, locomotiva diesel-elettrica BB 667548, livrea gialla “INFRA”

SNCF Infra, locomotora diésel BB 667548, decoración amarillo “INFRA”

SNCF Infra, diesel-electric locomotive BB 667548, yellow livery “Infra”



Pare-soleil avant



Vossloh DE 18



Les locomotives diesel-électriques **Vossloh DE 18** sont de véritables bijoux de technologie sur le réseau ferroviaire européen, et les modèles **HJ2471/S** d'**Europoorte** en livrée argent/bleue et **HJ2472/S** de **Millet Rail** en livrée orange/grise ne font pas exception. La conception de la Vossloh DE 18 a été influencée par des innovations dans l'efficacité énergétique.

Depuis leur lancement sur le marché en 2014, Vossloh a vendu plus de 130 locomotives DE 18 à plusieurs clients dans divers pays européens, comme la SNCF/Akiem, la DB et, plus récemment, le FS italien. Les locomotives fonctionnent aujourd'hui de manière fiable pour manoeuvres et comme locomotives de ligne.

Les points forts

- Châssis en zamak
- Carrosserie en plastique de haute qualité
- Moteur de haute performance à cinq pôles avec volants d'inertie
- Inversion des feux en fonction du sens de marche, feux qui peuvent être commutés séparément (avant et arrière) en mode numérique
- Éclairage intérieur dans la cabine du conducteur
- Tableau de bord lumineux
- Attelages numériques pour les versions digitales

HJ2471/HJ2471S



EUROPORTE, locomotive diesel-electrique type Vossloh DE 18, livrée argent/bleue
EUROPORTE, dieselelektrische Lokomotive des Typs Vossloh DE 18, silber/blaue Farbgebung
EUROPORTE, locomotiva diesel-elettrica Vossloh DE 18, livrea argento/blu
EUROPORTE, locomotora diésel Vossloh DE 18, decoración plateada/azul
EUROPORTE, diesel-electric locomotive Vossloh DE 18, silver/blue livery

NEW

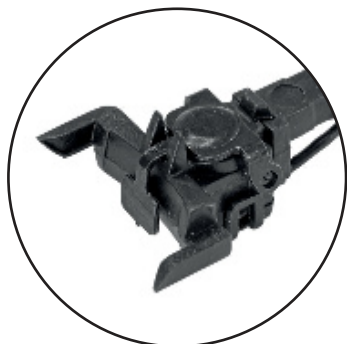

Attelages fonctionnels numériques



Photomontage / Fotomontage / Fotomontaggio / Fotomontaje

HJ2472/HJ2472S



Millet Rail, locomotive diesel-electrique type Vossloh DE 18, livrée orange/grise
Millet Rail, dieselelektrische Lokomotive des Typs Vossloh DE 18, orange/grau Farbgebung
Millet Rail, locomotiva diesel-elettrica Vossloh DE 18, livrea arancio/grigio
Millet Rail, locomotora diésel Vossloh DE 18, decoración naranja/gris
Millet Rail, diesel-electric locomotive Vossloh DE 18, orange/grey livery

NEW



Attelages fonctionnels numériques



Photomontage / Fotomontage / Fotomontaggio / Fotomontaje

HJ2468/HJ2468S



NEW



SNCF, locomotive électrique bicourant BB 26019, livrée bleue « Trains Spéciaux »
SNCF, elektrische Zweisystemlokomotive BB 26019, dunkelblaue Farbgebung „Trains Spéciaux“
SNCF, locomotiva elettrica bicorrente BB 26019, livrea blu “Trains Spéciaux”
SNCF, locomotora eléctrica bitensión BB 26019, “Trains Spéciaux”
SNCF, electric locomotive BB 26019 “Trains Spéciaux”, dark blue livery



Photomontage / Fotomontage / Fotomontaggio / Fotomontaje

Le BB 26019 dans une nouvelle robe bleue

« **Trains Spéciaux** » est un service offert par SNCF Voyageurs permettant de privatiser en partie ou totalement un train de voyageurs, depuis la rame TGV jusqu'au TER en passant par le train Intercités.

Afin d'identifier les locomotives affectées à la traction de ces trains spéciaux, SNCF Voyageurs a décidé d'appliquer une nouvelle décoration à certaines locomotives Sybic. Cette nouvelle robe est à base de bleu nuit et de filets dorés. Elle s'harmonise parfaitement avec la livrée bleue CIWL des luxueuses voitures-lits du train Venise-Simplon-Orient-Express.



HJ2469/HJ2469S



SNCF, locomotive électrique bicourant BB 426086, livrée « FRET » avec logo Carmillon, (Blason Cognac)
SNCF, elektrische Zweisystemlokomotive BB 426086, „FRET“-Farbgebung mit Carmillon-Logo, (Wappen Cognac)
SNCF, locomotiva elettrica bicorrente BB 426086, livrea “FRET” con logo Carmillon, (Stemma Cognac)
SNCF, locomotora eléctrica bitensión BB 426086, decoración “FRET” con logotipo Carmillon, (Escudo Cognac)
SNCF, electric locomotive BB 426086, “FRET” livery with Carmillon logo, (Coat of Arms Cognac)



Blason de la ville de Cognac



NEW

HJ2470/HJ2470S



SNCF, locomotive électrique bicourant BB 26163R, livrée « fluo Grand Est »
SNCF, elektrische Zweisystemlokomotive BB 26163R, in grauer „fluo Grand Est“-Farbgebung
SNCF, locomotiva elettrica bicorrente BB 26163R, livrea “fluo Grand Est”
SNCF, locomotora eléctrica bitensión BB 26163R, decoración “fluo Grand Est”
SNCF, electric locomotive BB 26163R, “fluo Grand Est” livery



NEW

HJ2453/HJ2453S

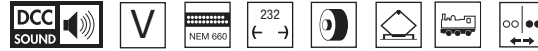

NEW



SNCF, locomotive électrique CC 406504 « Vitry-sur-Seine » en livrée « FRET »

SNCF, Elektrolokomotive CC 406504 „Vitry-sur-Seine“ in grüner „FRET“-Farbgebung

SNCF, locomotiva elettrica CC 406504 “Vitry-sur-Seine”, livrea “FRET”

SNCF, locomotora eléctrica CC 406504 “Vitry-sur-Seine”, decoración verde “FRET”

SNCF, electric locomotive CC 406504 “Vitry-sur-Seine” in green “FRET” livery



Nouvelle face avant de la locomotive avec logo SNCF rectangulaire



Pantographes entièrement fabriqués en métal et conformes à l'original



La CC 406504 FRET:

- Nouvelle forme de toit corrigée
- Nouveaux essuie-glaces
- Nouvelle face avant de la locomotive avec logo SNCF rectangulaire
- Pantographes entièrement fabriqués en métal et conformes à l'original
- Moteur avec volant d'inertie
- Prise de courant par caténaire fonctionnelle
- Châssis en zamak avec carrosserie en plastique
- Eclairage avec inversion blanc/rouge

HJ2454/HJ2454S



SNCF, locomotive bi-courant CC 21001, livrée Grand Confort avec logo nouille
SNCF, Mehrsystem-Elektrolokomotive CC 21001 in Grand-Confort-Farbgebung mit "Nudellogo »
SNCF, locomotiva bicorrente CC 21001, livrea Grand Confort con logo "Nouille"
SNCF, locomotora multisistema CC 21001, decoración "Grand Confort" con logo "Nouille"
SNCF, multi-system locomotive CC 21001 in Grand Confort livery with logo nouille

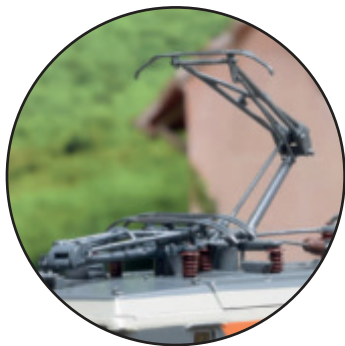

Pantographes entièrement fabriqués
en métal et conformes à l'original



ÉTOILEduNORD

1927-1939

Caractéristiques techniques des nouveaux voitures CIWL Pullman

- Nouveaux moules pour caisses, vitrages et intérieurs des voitures CIWL « Étoile du Nord » des types VP (sans cuisine) et VPC (avec cuisine)
- Toutes les voitures (à l'exception des fourgons à bagages) sont équipées du système de contact d'éclairage permettant de contrôler l'éclairage intérieur, aussi bien sur des réseaux analogiques que numériques
- Tous les détails de la toiture, têtes et châssis reproduits et différents entre VP et VPC
- Nouvelle décoration inédite pour Jouef, reproduisant la première livrée du train Pullman « Étoile du Nord » bleu/beige avec toit blanc et lets dorés et bleus
- Composition du train et détails des voitures cohérents avec la période à partir de l'hiver 1928-1929
- Toutes les voitures Pullman dans ces articles sont équipées d'un éclairage intérieur avec commande tactile pour activer et varier l'intensité
- Toutes les voitures sont équipées d'attelage court avec boîtier NEM 362 et des tampons à ressort

« Étoile du Nord »

L'Étoile du Nord était un train reliant Paris à Amsterdam via Bruxelles qui circula à partir des années 1920 jusqu'au milieu des années 1990.





Ce train, d'abord composé de voitures Pullman de la Compagnie des wagons-lits tracté par des locomotives à vapeur.

L'Étoile du Nord a commencé à circuler entre Paris et Bruxelles pendant les années 1920 et était exploité par les Chemins de Fer du Nord et la SNCB. Lorsqu'en 1927, la Compagnie des wagons-lits reprend l'exploitation de ce train, Amsterdam sera la nouvelle destination 1,2. En 1957, avec l'arrivée d'un tout nouveau matériel diesel, la ligne de l'Étoile du Nord est étendue jusqu'à Amsterdam et ce train est intégré au pool Trans-Europ-Express. Les premières voitures de voyageurs ont été les luxueuses voitures Pullman de la Compagnie des wagons-lits jusqu'à la fin des années 50.

HJ4198



NEW

-  **CIWL, coffret de 3 voitures « Etoile du Nord », set 1/2 (1 x DD3, 1 x VP Flèche d'Or et 1 x VPC Étoile du Nord)**
-  CIWL, dreiteiliges Set „Etoile du Nord“, Set 1/2 (1 x DD3, 1 x VP Flèche d'Or und 1 x VPC Étoile du Nord)
-  CIWL, set di 3 carrozze “Etoile du Nord”, set 1/2 (1 x DD3, 1 x VP Flèche d'Or e 1 x VPC Étoile du Nord)
-  CIWL, primer set de 3 coches “EC Etoile du Nord”, compuesto de un coche DD3, un VP “Flèche d’Or” + un VPC “Étoile du Nord”
-  CIWL, 3-unit pack “Etoile du Nord”, set 1/2 (1 x DD3, 1 x VP Flèche d'Or and 1 x VPC Étoile du Nord)

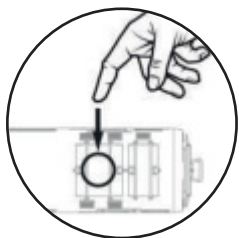





Voitures équipées de éclairage intérieur avec commande tactile pour activer et varier l'intensité



HJ4199



NEW

-  **CIWL, coffret de 3 voitures « Etoile du Nord », set 2/2 (1 x DD3, 1 x VPC Flèche d'Or and 1 x VP Étoile du Nord)**
-  CIWL, dreiteiliges Set „Etoile du Nord“, Set 2/2 (1 x DD3, 1 x VPC Flèche d'Or und 1 x VP Étoile du Nord)
-  CIWL, set di 3 carrozze “Etoile du Nord”, set 2/2 (1 x DD3, 1 x VPC Flèche d'Or e 1 x VP Étoile du Nord)
-  CIWL, segundo set de 3 coches “EC Etoile du Nord”, compuesto de un coche DD3, un VPC “Flèche d’Or” y un VP “Étoile du Nord”
-  CIWL, 3-unit pack “Etoile du Nord”, set 2/2 (1 x DD3, 1 x VPC Flèche d'Or and 1 x VP Étoile du Nord)

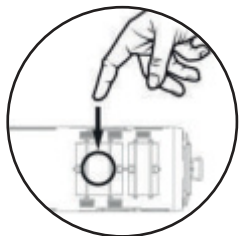

Voitures équipées de éclairage intérieur avec commande tactile pour activer et varier l'intensité



HJ4205



-  **SNCF, coffret de 4 voitures "Mistral 69" TEE « Jules Verne », n.1/2**
- SNCF, 4-tlg. Set TEE „Jules Verne“, (Set 1 von 2)
- SNCF, set di 4 carrozze "Mistral 69" TEE "Jules Verne", n.1/2
- SNCF, set de 4 coches TEE "Jules Verne", (set 1 de 2)
- SNCF, 4-unit set of TEE "Mistral 69" coaches "Jules Verne", no. 1/2

NEW

La série **Mistral 69**, lancée en 1969, en particulier les voitures TEE « Jules Verne » reliait Paris à différentes grandes villes, tout en proposant une ambiance raffinée à bord, avec des sièges confortables, des services de restauration, et un design inspiré par l'œuvre de l'écrivain éponyme.

Jeux de roues AC appropriés: HC6105 (10.30 x 23.50 mm) nécessite l'installation d'un patin de prise de courant pour que le système d'éclairage CLS fonctionne en courant alternatif (AC)

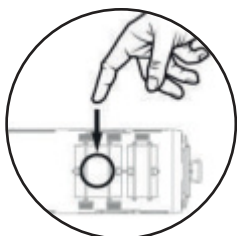

Voitures équipées de éclairage intérieur avec commande tactile pour activer et varier l'intensité



Photomontage / Fotomontage / Fotomontaggio / Fotomontaje

HJ4206HM

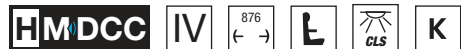

NEW

-  **SNCF, coffret de 3 voitures TEE « Jules Verne », n.2/2**
- SNCF, 3-tlg. Set TEE „Jules Verne“ (Set 2 von 2)
- SNCF, set di 3 carrozze “Mistral 69” TEE “Jules Verne”, n.2/2
- SNCF, set de 3 coches TEE “Jules Verne” (set 2 de 2)
- SNCF, 3-unit set of TEE “Mistral 69” coaches “Jules Verne”, no. 2/2

Jeux de roues AC appropriés: HC6105 (10.30 x 23.50 mm) nécessite l'installation d'un patin de prise de courant pour que le système d'éclairage CLS fonctionne en courant alternatif (AC)

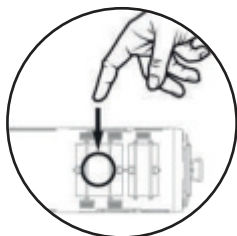

Voitures équipées de éclairage intérieur avec commande tactile pour activer et varier l'intensité



Photomontage / Fotomontage / Fotomontaggio / Fotomontaje

Le TEE « Jules Verne »

Le TEE « Jules Verne » circulait le matin de Nantes à Paris avec le numéro TEE 30 et en fin d'après-midi de Paris à Nantes avec le numéro TEE 31, avec un unique arrêt intermédiaire à Angers. À sa création, le 28 septembre 1980, il est tracté par une CC 72000, même sur la section électrifiée entre Le Mans et Paris. Ses horaires de circulation sont proches de ceux du Maine Océan et la durée du trajet est de 3 h 17 dans chaque sens.

Les voitures des nouveaux articles Jouef **HJ4205** et **HJ4206HM** sont équipées du système innovant d'éclairage par contact, fonctionnant aussi bien en mode analogique qu'en mode numérique. Ce système s'active simplement en touchant du bout du doigt un point précis sur la partie supérieure du toit de chaque voiture.

De plus, l'article **HJ4206HM** est doté d'un décodeur sonore Hornby BLE qui reproduit le son d'origine du moteur diesel du fourgon générateur. Ce décodeur peut être contrôlé via Bluetooth à l'aide de votre téléphone mobile ou tablette, sans nécessairement posséder une centrale numérique, ou par DCC, bien entendu.

HJ4207



NEW



SNCB/SNCF, coffret « Train Auto-Couchette », composé de 1 x WR SNCB ex CIWL + 1 x WL T2 SNCF + 1 x DD SNCB

SNCB/SNCF, Autoreisezug, bestehend aus WR (ex CIWL) SNCB + SNCF, WL T2 + DDm Autotransportwagen

SNCB/SNCF, set "Train Auto-Couchette", composto da 1 x WR SNCB ex CIWL + 1 x WL T2 SNCF + 1 x DD SNCB

SNCB/SNCF, tren nocturno con autoexpreso, incluye WR (ex CIWL) SNCB + SNCF, WL T2 + vagón portacoches DDm

SNCB/SNCF, set motorail train, including 1 x WR SNCB ex CIWL + 1 x WL T2 SNCF + 1 x DD SNCB



Photomontage / Fotomontage / Fotomontaggio / Fotomontaje



HJ2454



HJ4176-1



HJ4176-2

HJ4207-1

HJ4208



NEW



CIWL, voiture-restaurant « Libre-Service »

CIWL, Speisewagen „Libre-Service“, blaue Farbgebung

CIWL, carrozza ristorante “Libre-Service”

CIWL, coche restaurante “Libre-Service”

CIWL, restaurant coach “Libre-Service”, blue livery

Jeux de roues AC appropriés: HC6102 (10.50 x 24.50 mm) nécessite l'installation d'un patin de prise de courant pour que le système d'éclairage CLS fonctionne en courant alternatif (AC)

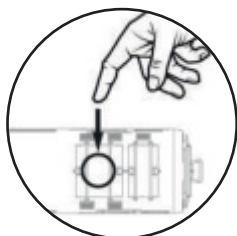

Voiture équipée de éclairage intérieur avec commande tactile pour activer et varier l'intensité



Photomontage / Fotomontage / Fotomontaggio / Fotomontaje

CIWL et l'Innovation du Voyage de Luxe

La Compagnie Internationale des Wagons-Lits (CIWL) incarne l'élégance et l'innovation dans l'univers du transport ferroviaire.

Parmi ses créations les plus emblématiques figure la voiture-restaurant « Libre-Service », une idée révolutionnaire qui a transformé l'art de dîner en voyage. En proposant un service rapide et accessible sans compromis sur la qualité, la voiture-restaurant « Libre-Service » a démocratisé l'expérience culinaire haut de gamme, offrant aux voyageurs un parfait équilibre entre praticité et raffinement.

Chaque détail, du design fonctionnel des intérieurs aux menus soigneusement élaborés, reflétait l'engagement de la CIWL à faire de chaque trajet une expérience unique et inoubliable. Les cuisines des voitures-restaurants étaient de véritables chefs-d'œuvre d'ingénierie : des espaces ultra-compacts où des chefs talentueux préparaient des plats dignes des meilleurs restaurants, souvent dans des conditions de mouvement et d'espace réduites.



HJ4207-2

HJ4207-3

HJ4209

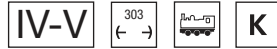

NEW



SNCF, wagon porte-autos DD DEV 66, livrée verte avec logo blanc « Encadré », avec des panneaux de protection semi-transparents

SNCF, Autotransportwagen DD DEV 66, grün mit weißem „Encadré“-Logo, mit semitransparenten Schutzpanelen

SNCF, carro trasporto auto DD DEV 66, livrea verde con logo “Encadré” bianco, con griglie laterali di protezione

SNCF, vagón portacoche DD DEV 66, decoración verde con logotipo blanco “Encadré”, con paneles de protección semitransparentes

SNCF, car transporter DD DEV 66, green with white “Encadré” logo, with semi-transparent protective panels



© Jean-Philippe Thernisien

Caractéristiques de notre nouveau wagon transporteur de voitures JOUEF de type DEV DD66 :

- Outillage entièrement nouveaux
- Châssis en métal coulé sous pression, offrant au wagon la stabilité requise, un centre de gravité bas et, par conséquent, d'excellentes caractéristiques de roulage
- Bogies, tampons, mains courantes, grilles latérales et autres petits détails selon la version et la série de production des véhicules réels
- Toutes les mains courantes sont en acier inoxydable
- De nombreux détails ajoutés sur le châssis, y compris les leviers du système de freinage
- Gravure fine et très détaillée des tôles cannelées sur les niveaux supérieur et inférieur
- Attelages courts conformes à la norme NEM 352 aux deux extrémités
- Barres de verrouillage des voitures sont à poser (pré-assemblées d'usine pour le niveau inférieur)
- *Dérivés du modèle français JOUEF pour l'Allemagne et la République tchèque distribués par Rivarossi*

HJ4188

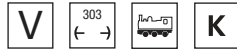

SNCF, fourgon porte-autos DD DEV 66, livrée verte avec logo « Casquette » blanc

SNCF, Autotransportwagen DD DEV 66 in grüner Farbgebung mit weißem „Casquette“-Logo

SNCF, carro DD DEV 66 per trasporto auto al seguito, livrea verde con logo “Casquette” bianco

SNCF, vagón portacoche tipo DD DEV 66, decoración verde con logo “Casquette” blanco

SNCF, car transporter DD DEV 66, green livery with white logo “Casquette”

NEW



Version d'origine des mains courantes sur le pont supérieur



HJ4189



SNCF, fourgon porte-autos DD DEV 66, 2^{ème} série, livrée verte avec logo « Carmillon » blanc

SNCF, Autotransportwagen DD DEV 66 der 2. Bauserie in grüner Farbgebung mit weißem „Carmillon“-Logo

SNCF, carro DD DEV 66 per trasporto auto al seguito, 2ª serie, livrea verde con logo “Carmillon” bianco

SNCF, vagón portacoche tipo DD DEV 66, segunda subserie, decoración verde con logo “Carmillon”

SNCF, car transporter DD DEV 66, 2nd series, green livery with white logo “Carmillon”

NEW



Version modernisée des mains courantes sur le pont supérieur

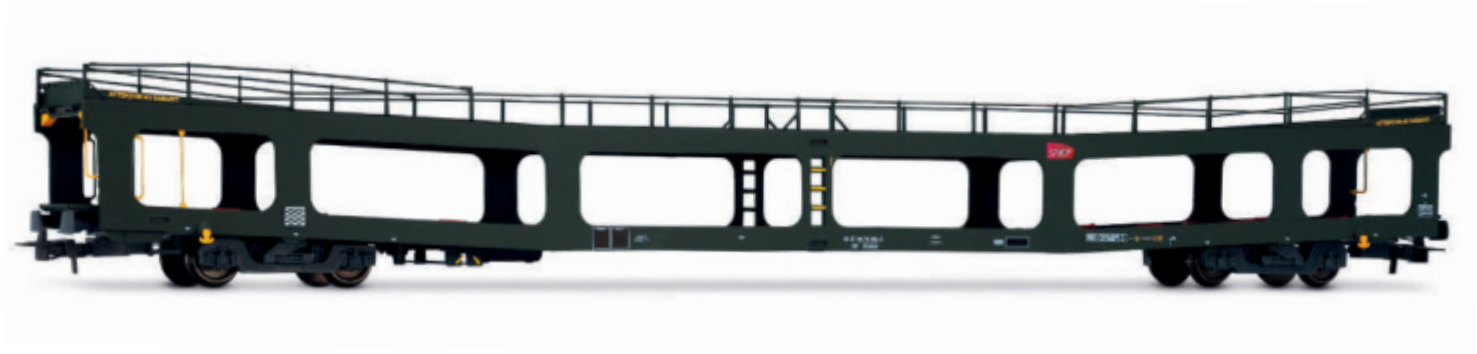

HJ4191



SNCF, coffret de 3 voitures Grand Confort TEE « Le Kléber » (1 x A8u, 1 x A8tu + 1 x Vru) en livrée « Grand Confort » gris béton

SNCF, dreiteiliges Set Gran Confort-Wagen TEE „Le Kléber“ (1 x A8u, 1 x A8tu + 1 x Vru) in gris béton „Grand Confort“-Farbgebung

SNCF, set di 3 carrozze Grand Confort TEE “Le Kléber” (1 x A8u, 1 x A8tu + 1 x Vru) in livrea gris béton “Grand Confort”

SNCF, primer set de 3 coches Gran Confort, TEE “Le Kléber”, compuesto de un coche A8u, un A8tu y un Vru, decoración gris béton

SNCF, 3-unit pack Gran Confort coaches TEE “Le Kléber” (1 x A8u, 1 x A8tu + 1 x Vru) in gris béton “Grand Confort” livery

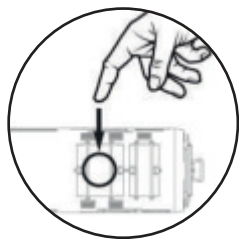

Voitures équipées de éclairage intérieur avec commande tactile pour activer et varier l'intensité



HJ4192



SNCF, coffret de 3 voitures Grand Confort TEE « Le Kléber » (1 x A8u, 1 x A8tu, 1 x A4Dtux) en livrée « Grand Confort » gris béton

SNCF, dreiteiliges Set Gran Confort-Wagen TEE „Le Kléber“ (1 x A8u, 1 x A8tu, 1 x A4Dtux) in gris béton „Grand Confort“-Farbgebung

SNCF, set di 3 carrozze Grand Confort TEE “Le Kléber” (1 x A8u, 1 x A8tu, 1 x A4Dtux) in livrea gris béton “Grand Confort”

SNCF, segundo set de 3 coches Gran Confort, TEE “Le Kléber”, compuesto de un coche A8u, un A8tu y un A4Dtux, decoración gris béton

SNCF, 3-unit pack Gran Confort coaches TEE “Le Kléber” (1 x A8u, 1 x A8tu, 1 x A4Dtux) in gris béton “Grand Confort” livery

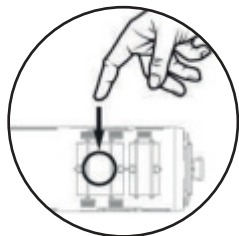

Voitures équipées de éclairage intérieur avec commande tactile pour activer et varier l'intensité



HJ4193



SNCF, voiture supplémentaire Grand Confort A8u pour TEE « Le kléber », livrée « Grand Confort » gris béton

SNCF, Gran-Confort-Ergänzungswagen A8u für TEE „Le Kléber“ in gris béton „Grand Confort“-Farbgebung

SNCF, carrozza aggiuntiva Grand Confort A8u per TEE “Le Kléber”, livrea gris béton “Grand Confort”

SNCF, coche adicional Gran Confort TEE “Le Kléber”, tipo A8u, decoración gris béton “Betón”

SNCF, supplementary Gran Confort coach A8u for TEE “Le Kléber” in gris béton “Grand Confort” livery

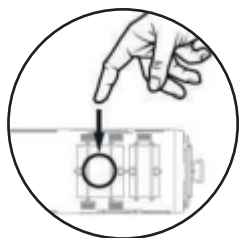

Voiture équipée de éclairage intérieur avec commande tactile pour activer et varier l'intensité



HJ4194



SNCF, voiture supplémentaire Grand Confort A8tu pour TEE « Le Kléber », livrée « Grand Confort » gris béton

SNCF, Gran-Confort-Ergänzungswagen A8tu für TEE „Le Kléber“ in gris béton „Grand Confort“-Farbgebung

SNCF, carrozza aggiuntiva Grand Confort A8tu per TEE “Le Kléber”, livrea gris béton “Grand Confort”

SNCF, coche adicional Gran Confort TEE “Le Kléber”, tipo A8tu, decoración gris béton “Betón”

SNCF, supplementary Gran Confort coach A8tu for TEE “Le Kléber” in gris béton “Grand Confort” livery

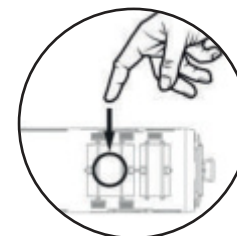

Voiture équipée de éclairage intérieur avec commande tactile pour activer et varier l'intensité

Le TEE « Kléber »

Le Kléber était un train express TEE qui a relié Strasbourg et Paris, en France, entre 1971 et 1988. Le train a été baptisé en l'honneur de Jean Baptiste Kléber, un général français né à Strasbourg pendant les guerres de la Révolution française.

Le Kléber a été mis en service le 23 mai 1971. Le 26 septembre 1982, le service TEE 60 du matin est supprimé. Son nom est transféré au service du soir TEE 62 Strasbourg - Paris, qui était auparavant le TEE Stanislas.

Ce dernier devient le Rapide Stanislas, conservant le même horaire de fin de matinée au départ de Paris et reprenant l'horaire matinal de Kléber au départ de Strasbourg.

Le TEE 62, rebaptisé Kléber (ex-TEE Stanislas), continue de partir de Strasbourg à 17h10 et d'arriver à Paris à 21h00. Les TEE 62 / TEE 61 ont cessé d'exister en tant que trains séparés en 1988, lorsqu'ils ont été intégrés dans un train international entre Paris et Stuttgart Hbf à Stuttgart, en Allemagne.



HJ6290

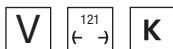

SNCF, wagon couvert à 2 essieux G4 « D.A.C.F.I. » (Dispositif d'Annonce pour Chantier Fixe Importants) Metz, livrée verte

SNCF, 2-achs. gedeckter Güterwagen G4 „D.A.C.F.I.“ Metz, grüne Farbgebung

SNCF, carro coperto a 2 assi G4 “D.A.C.F.I.” Metz, livrea verde

SNCF, vagón cerrado de 2 ejes G4 “D.A.C.F.I.” Metz, decoración verde

SNCF, 2-axle covered wagon G4 “D.A.C.F.I.” Metz, green livery



Jeux de roues AC appropriés: HC6104 (11.27 x 24.25 mm)

NEW

HJ6291

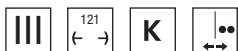

SNCF, wagon couvert à 2 essieux K4, avec feux arrière rouges (pile non incluse)

SNCF, 2-achs. gedeckter Güterwagen K4, mit roten Schlusslichtern (Batterie nicht enthalten)

SNCF, carro coperto a 2 assi K4, con fanali posteriori rossi (batteria non inclusa)

SNCF, vagón cerrado de 2 ejes K4, con luces traseras rojas (pila no incluida)

SNCF, 2-axle covered wagon K4, with red rear lights (battery not included)



Avec feux fin de convoi



Jeux de roues AC appropriés: HC6104 (11.27 x 24.25 mm)

NEW



HJ6311

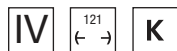

SNCF, wagon couvert à 2 essieux type Us (ex G4) « V » en livrée grise (gare de Bretigny)
 SNCF, 2-achs. gedeckter Güterwagen Typ Us (ex G4) „V“ in grauer Farbgebung (Bahnhof Bretigny)
 SNCF, carro coperto a 2 assi tipo Us (ex G4) “V” in livrea grigia (stazione di Bretigny)
 SNCF, vagón cerrado de 2 ejes tipo Us (ex G4) “V” en decoración gris (estación de Bretigny)
 SNCF, 2-axle covered wagon Us type (ex G4) “V” in grey livery (station of Bretigny)

NEW

Jeux de roues AC appropriés: HC6104 (11.27 x 24.25 mm)



Photomontage / Fotomontage / Fotomontaggio / Fotomontaje

HJ6300

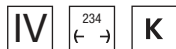

SNCF, wagon à parois coulissantes à 4 essieux type Habis « EVS », livrée argentée

SNCF, 4-achs. Schiebewandwagen Typ Habis „EVS“, silberne Farbgebung

SNCF, carro a pareti scorrevoli a 4 assi tipo Habis “EVS”, livrea argento

SNCF, vagón de paredes corredizas de 4 ejes tipo Habis “EVS”, decoración plateada

SNCF, 4-axle sliding-walls wagon type Habis “EVS”, silver livery

NEW

Jeux de roues AC appropriés: HC6100 (10.27 x 25,20 mm)



Photomontage / Fotomontage / Fotomontaggio / Fotomontaje

HJ6301

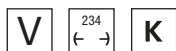

SNCF, wagon à parois coulissantes à 4 essieux type Habis « FRET »

SNCF, 4-achs. Schiebewandwagen Typ Habis „FRET“

SNCF, carro a pareti scorrevoli a 4 assi tipo Habis “FRET”

SNCF, vagón de paredes corredizas de 4 ejes tipo Habis “FRET”

SNCF, 4-axle sliding-walls wagon type Habis “FRET”

NEW

Jeux de roues AC appropriés: HC6100 (10.27 x 25,20 mm)



Photomontage / Fotomontage / Fotomontaggio / Fotomontaje

HJ6308

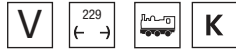

SNCF, wagon plateforme à 4 essieux type Res, chargé de bogies Y25

SNCF, 4-achs. Flachwagen Typ Res, beladen mit Y25-Drehgestellen

SNCF, carro pianale a 4 assi tipo Res, con carrelli Y25

SNCF, vagón plataforma de 4 ejes tipo Res, cargado con bogies Y25

SNCF, 4-axle stake wagon, Res type, loaded with Y25 bogies

NEW

Jeux de roues AC appropriés: HC6100 (10.27 x 25,20 mm)

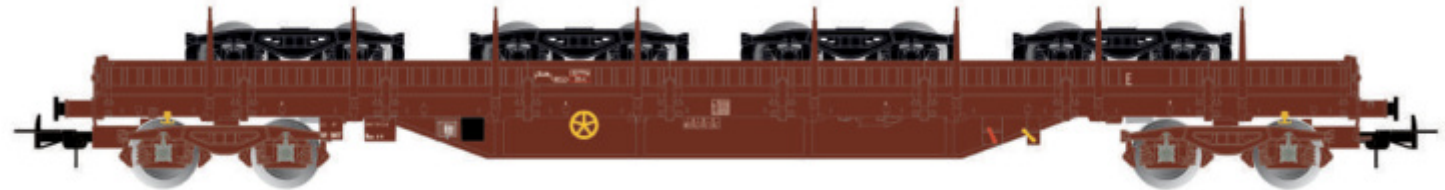

HJ6309

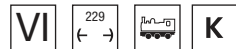

SNCF Infra, wagon plateforme à 4 essieux type Uas (ex Res)

SNCF Infra, 4-achs. Flachwagen Typ Uas (ex Res)

SNCF Infra, carro pianale a 4 assi tipo Uas (ex Res)

SNCF Infra, vagón plataforma de 4 ejes tipo Uas (ex Res)

SNCF Infra, 4-axle stake wagon, Uas type (ex Res)

NEW

Jeux de roues AC appropriés: HC6100 (10.27 x 25,20 mm)



HJ6310

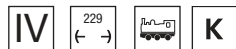

SNCF, wagon plateforme à 4 essieux type Rs avec 2 conteneurs de 20' « Citroën », en livrée blanche

SNCF, 4-achs. Flachwagen Typ Rs mit 2 x 20'-Containern „Citroën“, in weißer Farbgebung

SNCF, carro pianale a 4 assi tipo Rs con 2 container da 20' "Citroën", livrea bianca

SNCF, vagón plataforma de 4 ejes tipo Rs con 2 contenedores de 20' "Citroën" blancos

SNCF, 4-axle stake wagon, Rs type with 2 x 20' container "Citroën", in white livery

NEW

Jeux de roues AC appropriés: HC6100 (10.27 x 25,20 mm)



HJ6277

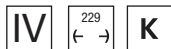

NEW



SNCF, wagon porte-conteneurs à 4 essieux S70, avec caisse mobile « 3 SUISSSES »

SNCF, 4-achs. Containerwagen S70, mit Wechselbehälter „3 SUISSSES“

SNCF, carro porta-container a 4 assi S70, con cassa mobile “3 SUISSSES”

SNCF, vagón portacontenedores de 4 ejes S70, con caja móvil “3 SUISSSES”

SNCF, 4-axle container wagon S70, loaded with swap body “3 SUISSSES”

Jeux de roues AC appropriés: HC6100 (10.27 x 25,20 mm)

Ce wagon était équipé de bogies spéciaux Y37 pour une vitesse maximale de 160 km/h. Plus tard, ils ont été remplacés par des bogies standard Y25.



Photomontage / Fotomontage / Fotomontaggio / Fotomontaje

HJ6278

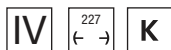

NEW



SNCF, wagon porte-conteneurs à 4 essieux S70, avec 2 conteneurs de 20' « FB »

SNCF, 4-achs. Containerwagen S70, mit 2 x 20'-Containern „FB“



SNCF, carro porta-container a 4 assi S70, con 2 x container da 20' “FB”

SNCF, vagón portacontenedores de 4 ejes S70, con 2 contenedores de 20' “FB”

SNCF, 4-axle container wagon S70, loaded with 2 x 20' container “FB”

Jeux de roues AC appropriés: HC6100 (10.27 x 25,20 mm)



Photomontage / Fotomontage / Fotomontaggio / Fotomontaje

HJ6279

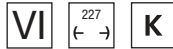

NEW



TOUAX, wagon porte-conteneurs à 4 essieux S70, avec caisse mobile « B. Dorchies »

TOUAX, 4-achs. Containerwagen S70, mit Wechselbehälter „B. Dorchies“

TOUAX, carro porta-container a 4 assi S70, con cassa mobile “B. Dorchies”

TOUAX, vagón portacontenedores de 4 ejes S70, con caja móvil “B. Dorchies”

TOUAX, 4-axle container wagon S70, loaded with swap body “B. Dorchies”

Jeux de roues AC appropriés: HC6100 (10.27 x 25,20 mm)



Photomontage / Fotomontage / Fotomontaggio / Fotomontaje

HJ6303

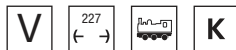

NEW



SNCF, wagon porte-conteneurs à 4 essieux Sgss de 60' Novatrans en livrée grise avec 2 conteneurs pour bobines de 20' « Spedirail » en livrée bleue

SNCF, 4-achs. 60' Containerwagen Novatrans Sgss in grauer Farbgebung, beladen mit 2 blauen 20'-Coil-Container „Spedirail“

SNCF, carro porta-container a 4 assi Sgss da 60' Novatrans in livrea grigia con 2 container per bobine da 20' “Spedirail”, in livrea blu

SNCF, vagón portacontenedores de 4 ejes Novatrans Sgss 60', decoración gris, con 2 contenedores para bobinas de 20' “Spedirail”, azul

SNCF, 4-axle 60' container wagon Sgss Novatrans in grey livery with double 20' “Spedirail” coil container in blue livery

Jeux de roues AC appropriés: HC6100 (10.27 x 25,20 mm)



HJ6294

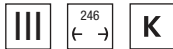

SNCF, coffret de 2 wagons-citernes à 3 essieux « ESSO », livrée argentée

SNCF, 2-tlg. Set 3-achs. Kesselwagen „ESSO“, silberne Farbgebung

SNCF, set di 2 carri cisterna a 3 assi "ESSO", livrea argento

SNCF, set de 2 wagones cisterna de 3 ejes "ESSO", decoración plateada

SNCF, 2-unit set of 3-axle tank wagons, "ESSO", silver livery

NEW

Jeux de roues AC appropriés: HC6104 (11.27 x 24.25 mm)



HJ6295

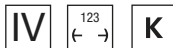

VTG, wagon-citerne à 3 essieux « Ateliers de Joigny »

VTG, 3-achs. Kesselwagen „Ateliers de Joigny“

VTG, carro cisterna a 3 assi "Ateliers de Joigny"

VTG, vagón cisterna de 3 ejes "Ateliers de Joigny"

VTG, 3-axle tank wagon "Ateliers de Joigny"

NEW

Jeux de roues AC appropriés: HC6104 (11.27 x 24.25 mm)



HJ6287

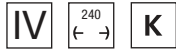

SNCF, coffret de 2 wagons cysternes à gaz à 2 essieux avec toit pare soleil, « Air Liquide »
SNCF, zweiteiliges Set zweiachsiger Gaskesselwagen mit Sonnenschutzdächern, „Air Liquide“
SNCF, set di 2 carri cisterna a 2 assi per trasporto gas con tettuccio parasole, “Air Liquide”
SNCF, set de 2 vagonos cisterna de 2 ejes para gas, con protector de techo, decoración “Air Liquide”
SNCF, 2-unit pack of 2-axle gas tank wagons with sun roof, “Air Liquide”

NEW

Jeux de roues AC appropriés: HC6101 (11.27 x 24,25 mm)



HJ6289

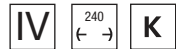

SNCF, coffret de 2 wagons cysternes à gaz à 2 essieux, « AGA Progas »
SNCF, zweiteiliges Set zweiachsiger Gaskesselwagen „AGA Progas“
SNCF, set di 2 carri a gas a 2 assi, “AGA Progas”
SNCF, set de 2 vagonos cisterna de 2 ejes para gas, decoración “AGA Progas”
SNCF, 2-unit pack gas tank wagons “AGA Progas”

NEW

Jeux de roues AC appropriés: HC6101 (11.27 x 24,25 mm)



HJ6228



NEW



F-ERSA, coffret de 2 wagons-trémies à 4 essieux Taoos, livrée marron, « Ermewa/Chemoil »
F-ERSA, 2-tlg. Set vierachs. Schwenkdachwagen Taoos, in brauner Farbgebung, „Ermewa/Chemoil“
F-ERSA, set di 2 carri tramoggia a 4 assi Taoos, livrea marrone, “Ermewa/Chemoil”
F-ERSA, set de 2 vagones tolva tipo Taoos, decoración “Ermewa/Chemoil” marrón
F-ERSA, 2-unit set of 4-axle hopper wagons Taoos, brown livery, “Ermewa/Chemoil”

Jeux de roues AC appropriés: HC6100 (10.27 x 25,20 mm)



Version avec châssis long et système de freinage supérieur

HJ6229

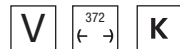

NEW



VTG FRANCE, coffret de 2 wagons-trémies à 4 essieux Taoos, livrée gris, « Simotra »
VTG FRANCE, 2-tlg. Set vierachs. Schwenkdachwagen Taoos, in grauer Farbgebung, „Simotra“
VTG FRANCE, set di 2 carri tramoggia a 4 assi Taoos, livrea grigia, “Simotra”
VTG FRANCE, set de 2 vagones tolva tipo Taoos, decoración “Simotra” gris
VTG FRANCE, 2-unit set of 4-axle hopper wagons Taoos, grey livery, “Simotra”

Jeux de roues AC appropriés: HC6100 (10.27 x 25,20 mm)



Version avec châssis long et système de freinage supérieur

HJ6230

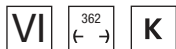

NACCO, coffret de 2 wagons-trémies à 4 essieux Taoos, livrée bleue
NACCO, 2-tlg. Set 4-achs. Schwenkdachwagen Taoos, in hellblauer Farbgebung
NACCO, set di 2 carri tramoggia a 4 assi Taoos, livrea blu
NACCO, set de 2 vagones tolva de tipo Taoos, decoración azul
NACCO, 2-unit set of 4-axle hopper wagons Taoos, light blue livery

NEW

Jeux de roues AC appropriés: HC6100 (10.27 x 25,20 mm)



Version NACCO avec châssis court

HJ6312

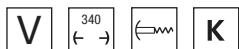

SNCF, coffret de 2 wagons trémies céréaliers à 4 essieux « SANDERS », livrée grise
SNCF, 2-tlg. Set 4-achs. Getreidesilowagen „SANDERS“, graue Farbgebung
SNCF, set di 2 carri silos a 4 assi “SANDERS”, livrea grigia
SNCF, set de 2 vagones tolva de 4 ejes “SANDERS”, decoración gris
SNCF, 2-unit set of 4-axle flat-sided silo wagons “SANDERS”, in grey livery

NEW

Jeux de roues AC appropriés: HC6100 (10.27 x 25,20 mm)



HJ6313

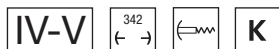

NEW

-  **SNCF, coffret de 2 wagons-trémies céréaliers « Transcéréales – CAF Grains », avec parois plates + bombées**
-  **SNCF, 2-tlg. Set Getreidesilowagen „Transcéréales – CAF Grains“, mit flachen + runden Wänden**
-  **SNCF, set di 2 carri tramoggia trasporto cereali “Transcéréales – CAF Grains”, con pareti piane + arrotondate**
-  **SNCF, set de 2 vagones tolva cerealera “Transcéréales – CAF Grains”, con paredes planas + redondeadas**
-  **SNCF, 2-unit set of cereal hopper wagons “Transcéréales – CAF Grains”, with flat + rounded walls**



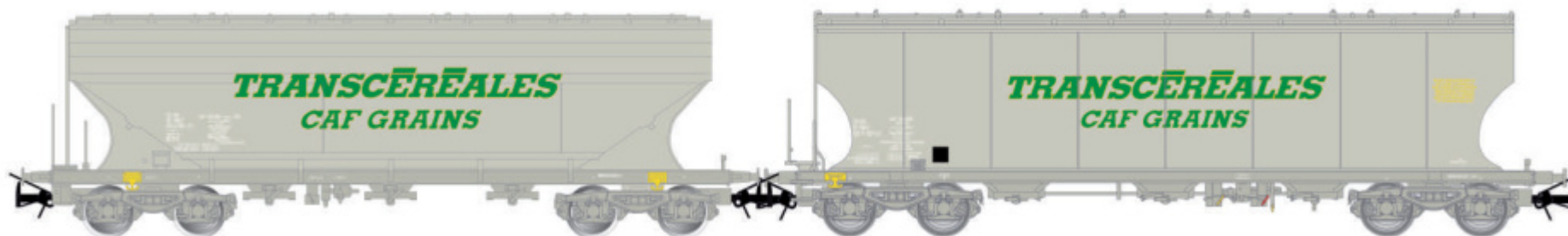

Jeux de roues AC appropriés: HC6100 (10,27 x 25,20 mm)

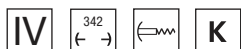

HJ6314



NEW

-  **SNCF, coffret de 2 wagons-trémies céréaliers « Transcéréales – Esmerly-Caron », avec parois plates + bombées**
-  **SNCF, 2-tlg. Set Getreidesilowagen „Transcéréales – Esmerly-Caron“, mit flachen + runden Wänden**
-  **SNCF, set di 2 carri tramoggia trasporto cereali “Transcéréales – Esmerly-Caron”, con pareti piane + arrotondate**
-  **SNCF, set de 2 vagones tolva cerealera “Transcéréales – Esmerly-Caron”, con paredes planas + redondeadas**
-  **SNCF, 2-unit set of cereal hoppers “Transcéréales – Esmerly-Caron”, with flat + rounded walls**

Jeux de roues AC appropriés: HC6100 (10,27 x 25,20 mm)

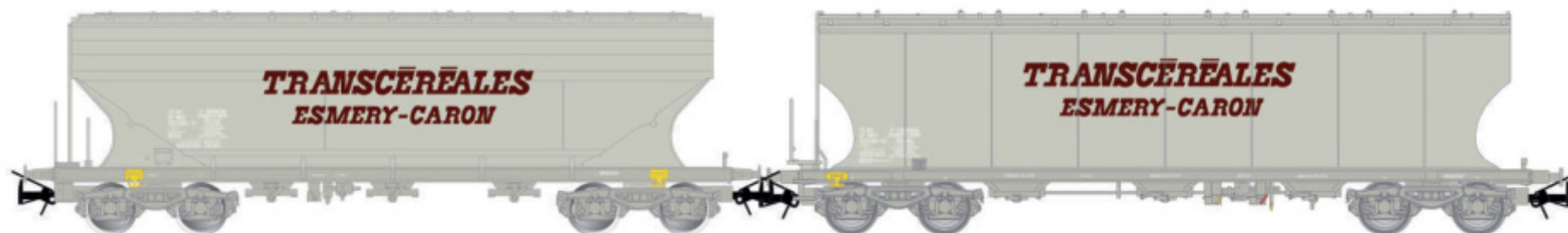

HJ6315

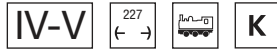

SNCF, wagon bâché à 4 essieux type Rils « FRET », livrée orange
SNCF, 4-achs. Schiebeplanenwagen Typ Rils „FRET“, orange Farbgebung
SNCF, carro telonato a 4 assi tipo Rils “FRET”, livrea arancio
SNCF, vagón entoldado de 4 ejes tipo Rils “FRET”, decoración naranja
SNCF, 4-axle tarpaulin wagon Rils type “FRET”, orange livery

NEW

Jeux de roues AC appropriés: HC6100 (10,27 x 25,20 mm)



Photomontage / Fotomontage / Fotomontaggio / Fotomontaje

HJ6316

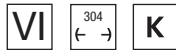

TRANSFESA/Hispanauto, wagon porte-voitures à 3 essieux Laeks « Mega Car Carrier », livrée bleue avec nouveau logo
TRANSFESA/Hispanauto, 3-achs. Autotransporter Laeks „Mega Car Carrier“, blaue Farbgebung mit neuem Logo
TRANSFESA/Hispanauto, carro trasporto auto a 3 assi Laeks “Mega Car Carrier”, livrea blu con nuovo logo
TRANSFESA/Hispanauto, vagón porta-coches de 3 ejes Laeks “Mega Car Carrier”, decoración azul con nuevo logo
TRANSFESA/Hispanauto, 3-axle car transporter Laeks “Mega Car Carrier”, blue livery with new logo

NEW

Jeux de roues AC appropriés: HC6103



Photomontage / Fotomontage / Fotomontaggio / Fotomontaje



Encore disponibles • Bereits lieferbar • Ancora disponibili • Aún disponibles • Still available

Les produits indiqués comme « déjà disponibles » pourraient être disponibles en quantité limitée ou déjà épuisés

Die als „bereits lieferbar“ gekennzeichneten Produkte könnten in begrenzter Menge verfügbar sein oder bereits ausverkauft sein

I prodotti segnalati come “ancora disponibili” potrebbero essere disponibili in quantità limitata o già esauriti

Los productos marcados como «aún disponibles» pueden estar disponibles en cantidad limitada o ya agotados

Products marked as “still available” may be available in limited quantity or already sold out



HJ2403

SNCB/NMBS, locomotive à vapeur classe 81, chaudière avec 3 coupoles symétriques, livrée vert foncé, ép. III



- Châssis, roues, chaudière, carrosserie du tender en métal injecté de haute qualité;
- Moteur avec volant d'inertie inclus dans la locomotive pour un roulement doux;
- Toutes les lanternes (LED à ton chaud) sont allumées en fonction du sens de circulation, en mode analogique;
- Avec boîte à feu lumineuse (DC) ou scintillant (en mode digital);
- Attelage court entre la locomotive et le tender;
- Longueur hors tampons 210mm;
- Prise pour interface numérique MTC 21 broches (NEM 660)



HJ2415/HJ2415S

SNCF, locomotive à vapeur 140 C 133, avec tender 18 B 12 (région Est), livrée verte/noire avec bandes rouges, ép. III



Photo: Bruno Miniature



HJ2416/HJ2416S

SNCF, locomotive à vapeur 140 C 158, avec tender 18 B 521 (région Ouest), livrée noire, ép. III



HJ2418/HJ2418S

SNCF, autorail à 2 voitures RGP II X 2717 avec remorque XR 7710, livrée vert/beige avec logo d'origine, ép. III



- Sans déflecteur de fumée
- Fanaux rouges arrière
- Feux anciens
- Pare-brise version d'origine
- Indicateurs de classe sur fond vert
- Rame de 2^{ème} classe (avant la réforme des classes de juin 1956)
- Remorque avec compartiment cuisine

HJ2419/HJ2419S

SNCF, autorail à 2 voitures RGP II X 2716 avec remorque XR 7719, avec déflecteurs de fumée, livrée vert/beige, ép. III



- Avec déflecteur de fumée
- Feux anciens et sans fanaux
- Indicateurs de classe sur fond vert
- Indicateurs de classe sur fond rouge pour la 2e classe, sur fond jaune pour la 1e classe
- Marquage de service de couleur gris en bas de caisse
- Remorque sans compartiment cuisine

HJ2420/HJ2420S

SNCF, autorail à 2 voitures RGP II X 2712 avec remorque XR 7714, avec déflecteurs de fumée, livrée vert/beige, ép. III



- Avec déflecteur de fumée
- Feux anciens
- Sans fanaux
- Livrée face avant différente
- Indicateurs de classe sur fond vert
- Rame de 1^{ère} classe (après la réforme de juin 1956)
- Remorque avec compartiment cuisine

HJ2429/HJ2429S

SNCF, autorail à 2 voitures RGP II X 2719 avec remorque XRAB 7708, avec déflecteurs de fumée, livrée vert/beige, ép. IV



- Avec déflecteur de fumée
- Feux modernisés et sans fanaux
- Nouveau logo SNCF/Plus d'enjoliveurs
- Indicateurs de classe sur fond rouge pour la 2e classe, sur fond jaune pour la 1e classe
- Remorque sans compartiment cuisine
- Marquage de service de couleur jaune en bas de caisse



HJ2418/S

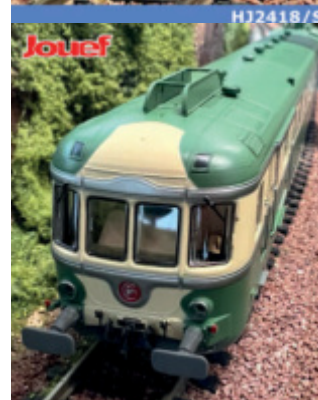

HJ2419/S



HJ2420/S



HJ2429/S



HJ2418/S



HJ2419/S



HJ2420/S



HJ2429/S

HJ2430

SNCF, locomotive à vapeur 141 R 44, avec 3 feux avant et tender à charbon, livrée verte/noire, dépôt Sarreguemines, ép. III



HJ2431

SNCF, locomotive à vapeur 141 R 484, avec 3 feux avant et tender à charbon, livrée noire, dépôt Hausbergen, ép. III



HJ2432

Locomotive à vapeur 141 R 420, avec tender à charbon, ép. V



- Ces nouvelles locomotives disposent d'une prise de courant sur le tender et les roues motrices
- Le châssis est métallique et le moteur avec volant d'inertie
- Il y a un éclairage cabine du plus bel effet et les tampons sont à ressorts
- Le rayon de courbure est de 356,5mm minimum
- La platine est à la norme Nem 660



HJ2433

Locomotive à vapeur 141 R 1244, tender fuel grande capacité, livrée verte/noire avec roues blanches, ép. V



HJ2441/HJ2441S

SNCF, locomotive diesel BB 666442, livrée bleue, ép. VI



HJ2442/HJ2442S

SNCF, locomotive diesel BB 66400, livrée verte, « FRET », ép. VI



Découvrez en détail la locomotive avec la vidéo de Bruno Miniature



HJ2425/HJ2425S

SNCF, coffret de 4 unités, TGV Sud-Est, 1981 version inaugurale, ép. IV



HJ3014

SNCF, coffret supplémentaire de 3 voitures TGV Sud-Est, 1981 version inaugurale, composé de 1^{ère} classe et 1 voiture bar, ép. V



HJ3015

SNCF, coffret supplémentaire de 3 voitures TGV Sud-Est, 1981 version inaugurale, composé de 3^{ème} classe, ép. V



HJ2425-1

HJ2425-2

HJ3014-1

HJ3014-2

HJ3014-3



HJ3015-1

HJ3015-2

HJ3015-3

HJ2425-3

HJ2425-4



HJ2440/HJ2440S

COLAS RAIL, locomotive diesel Vossloh DE 18, livrée orange/jaune, ép. VI



HJ2443/HJ2443S

SNCF, locomotive électrique BB 26212 avec 3 feux avant, livrée grise/orange avec logo « Casquette », ép. V



HJ2444/HJ2444S

SNCF, locomotive électrique BB 26056, livrée grise/rouge, « Technicentre Industriel Oullins », ép. VI



HJ2445/HJ2445S

SNCF, locomotive électrique BB 26144, livrée « TER Grand Est », ép. VI



- Nouvelle face avant de la locomotive avec essuie-glaces rapportés séparément (pièces photo découpées en acier inoxydable)
- Bogies nouvellement modélisés
- Nouvel aménagement intérieur avec une figurine de conducteur de locomotive qui salue
- Eclairage intérieur des cabines de conduite commutable en mode numérique
- Pantographes entièrement fabriqués en métal et conformes à l'original, différents pour la BB 26144

HJ2446/HJ2446S

SNCF, locomotive diesel BB 567556, livrée bleue avec logo « Casquette », ép. V



HJ2447/HJ2447S

SNCF, locomotive diesel BB167424 avec parois plates, livrée « Multiservice », ép. VI



HJ2449/HJ2449S

SNCF, locomotive électrique BB 12013 avec 2 fanaux hautes et 2 fanaux basses, livrée bleue/jaune avec plaques rouges, ép. III



HJ2450/HJ2450S

SNCF, locomotive électrique BB 13052 avec 4 lampes inférieures, livrée bleue, « Cité du Train », ép. IV



HJ2452/HJ2452S

SNCF, locomotive électrique CC 6526 « Le Capitole », ép. IV



- Boîte métallique commémorative de l'anniversaire
- Nouveau logo CAPITOLE sur l'une des faces avant
- L'emballage comprend un presse-papier en métal reproduisant la face avant de la locomotive CAPITOLE.
- L'article contient le livret « Jouef 80 ans 1944 - 2024 »

HJ2460/HJ2460S

Akiem, locomotive électrique tritension « Astride » BB 36011, nouvelle livrée Akiem, ép. VI



- Forme corrigée du toit de la cabine
- Pantographes entièrement en métal
- Moteur haute performance à 5 pôles à enroulement oblique avec volants d'inertie
- Châssis et bogies en métal moulé
- Feux blancs à l'avant et rouges à l'arrière, changeant de direction, contrôlables séparément en mode numérique
- Prise numérique MTC à 21 broches
- Les six essieux sont entraînés par des cardans.
- Toutes les roues sont équipées de capteurs de courant
- Pochettes d'attelage conformes à la norme NEM 362 des deux côtés de la locomotive
- Rayon minimum : 356,5 mm

HJ2459/HJ2459S

SNCF, locomotive électrique tritension « Astride » BB 36008 blasons « Blainville/Damelevières », livrée multiservice, ép. VI



HJ2458/HJ2458S

SNCF, locomotive électrique tritension « Astride » BB 36031, blasons « Bons-en-Chablais / Castione », livrée « FRET », ép. V



HJ2459

HJ6272

HJ6250

HJ6297

HJ4174

SNCF, coffret de 3 voitures courtes DEV Inox, composé de 1 voiture A8, 1 voiture A3B5 et 1 voiture BRT, ép. III

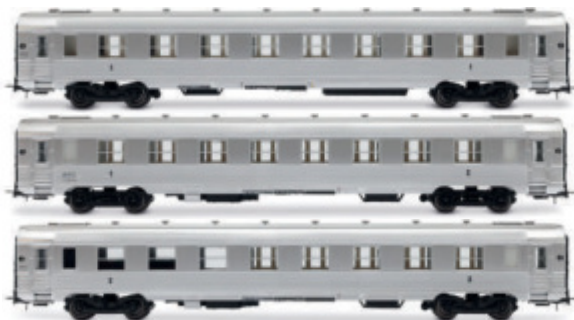

HJ4175

SNCF, coffret de 3 voitures courtes DEV Inox, composé de 2 voitures B8 et 1 voiture A6D, ép. III



HJ4176

SNCF, coffret de 2 voitures courtes DEV Inox, avec cartouche Corail, composé de 1 voiture A8 et 1 voiture B6D, ép. IV



- Nouveaux moules pour une reproduction fidèle et précise
- Intérieur finement détaillé avec sièges séparés pour plus de réalisme
- Dessous de caisse détaillé avec un équipement spécifique selon l'époque modélisée
- Coulisses d'attelage court conformes à la norme NEM 352 aux deux extrémités des voitures
- Boîtiers NEM 362 pour tête d'attelage interchangeable aux deux extrémités
- Rayon minimal d'inscription en courbe : 356,5 mm
- Châssis reproduit avec finesse et précision



HJ4177

SNCF, coffret de 2 voitures courtes DEV Inox B8, avec cartouche Corail, ép. IV

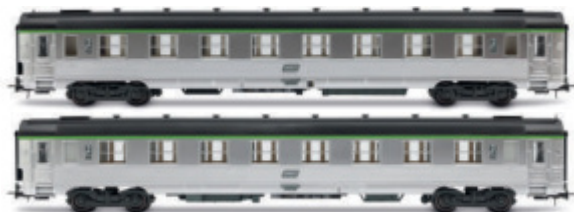

HJ4178

SNCF, coffret de 3 voitures, « Train Expo », coffret 1/2, ép. VI



HJ4179

SNCF, coffret de 3 voitures, « Train Expo », coffret 2/2, ép. VI



HJ4181

SNCF, coffret de 2 voitures DEV AO de 2^{ème} classe U59 B9 (ex A9), livrée verte/grise avec logo « Encadré », ép. IV



HJ4183

SNCF, coffret de 2 unités, train de maintenance, composé de 1 voiture DEV Inox et 1 wagon G4, ép. IV



HJ4182

SNCF, coffret de 2 voitures DEV AO de 2^{ème} classe U59 B9 (ex A9), livrée verte/grise avec logo « Nouille », ép. IV



Photo: Bruno Miniature



- Longueur : 576 mm
- Structure : Voitures avec un corps en plastique très détaillé, avec des finitions précises et réalistes, reproduisant les détails de la voiture réelle, y compris les fenêtres avec cadres et la livrée bicolore verte/grise.
- Bogies : Y24 réalistes, avec des suspensions détaillées et des roues en métal
- Intérieurs : Détails intérieurs soignés, avec reproduction des sièges, couloirs et spécificités des portes d'entrée.
- Le symbole stylisé de la SNCF (surnommé "Nouille" ou "Vermicelle" en raison de sa forme) est clairement visible sur les côtés de la voiture.

HJ4184

SNCF, coffret de 3 voitures RIO 80, livrée bleu/argent "Centre", ép. VI



HJ4185

SNCF, coffret de 4 voitures RIO 77, « Stelyrail bleu », ép. VI



HJ4186

SNCF, coffret de 3 voitures RIO 78 TER (ex NPDC), livrée jaune/argent, ép. VI





HJ4196

SNCF, coffret de 3 voitures « EC Etoile du Nord » set 1/2
(1 x A4Dtux, 1 x B8u et 1 x B91/2tu), ép. V



HJ4197

SNCF, coffret de 3 voitures « EC Etoile du Nord » set 2/2
(1 x Vru, 1 x A3rtu et 1 x A8u), ép. V



HJ4200

SNCF, coffret de 3 voitures Coca-Cola « Train de Noël »
de 2010, ép. VI



HJ6254

SNCF, wagon fermé à 2 essieux G4 avec parois lisses,
livrée "Coca Cola", ép. IV



 **HJ6239**

SNCF, wagon silo à 2 essieux Ucs, « Fixit », ép. V



 **HJ6250**

Coffret de 2 wagons-citernes pour le transport de chlore, VTG + Ermewa, livrée beige/orange/rouge, ép. VI



 **HJ6252**

SNCF, wagon bâché à 3 essieux type Lailps, livrée bleue, « Flumroc », ép. IV



 **HJ6247**

SNCF, coffret de 2 wagons-citerne à 3 essieux, « BP », ép. IV



 **HJ6248**

SNCF, coffret de 2 wagons-citerne à 3 essieux, « Europ Rail S.G.M.F. / Bruyere et Eberlet », ép. IV



 **HJ6249**

SNCF, coffret de 2 wagons-citerne à 3 essieux, « Petroles de L'Ouest », ép. IV



 **HJ6260**

SNCF, wagon porte-conteneurs à 4 essieux S70, chargé avec 2 conteneurs porte-bobines de 20' « TINES », ép. V



 **HJ6261**

TOUAX, wagon porte-conteneurs à 4 essieux S7B, chargé avec 2 Coil-containers de 20' « ONE », ép. V



 **HJ6264**

SNCF, coffret de 2 wagons-citerne à 2 essieux à gaz, « Primagaz », ép. III



 **HJ6267**

BRAMBLES, wagon plat de voitures à 3 essieux Laeks, livrée bleue, ép. IV



 **HJ6272**

F-ERSA, wagon à parois coulissantes à 4 essieux Habbiss, livrée grise/marron, « Ermewa », ép. VI



 **HJ6281**

SNCF, coffret de 2 wagons trémies à 4 essieux avec parois planes, « UFAC », ép. IV



 **HJ6292**

SNCF, wagon couvert à 2 essieux, 80^{ème} anniversaire JOUEF



 **HJ6293**

SNCF, coffret de 3 wagons tombereaux type Eamnos, ép. VI



 **HJ1062**

Jouef SNCF Infra Set de train électrique





Index • *Index*

Locomotives diesel.....60

Diesel locomotives.....60

Arrivées récentes.....62

Still available.....62

Jouef *Loisirs*[®]

Jouef Loisirs est la gamme de Jouef destinée à un public plus jeune et néophyte. Grâce à la capacité de Jouef Loisirs à s'adapter aux besoins de chacun, vous ne pourrez plus vous en passer.

De nouvelles livrées de locomotives et d'autres surprises vous attendent, profitez de ce catalogue conçu spécialement pour vous !



www.jouef.com

CC 72000

La locomotive diesel-électrique **CC 72006** de la série SNCF CC 72000 est particulièrement connue pour avoir été la seule de cette classe à arborer la célèbre livrée bleu multiservice, un choix unique et expérimental. Surnommée « Isabelle », cette locomotive a été peinte en **Bleu Multiservice** (également appelé “Corail +”), une couleur créée pour refléter l’image moderne de la SNCF dans les années 1990. En 1995, cette livrée a été appliquée dans le but de tester un style distinct pour les services mixtes, mais elle n’a jamais été adoptée par d’autres modèles de la série, ce qui a rendu cette version très spéciale et recherchée par les amateurs de trains et les modélistes ferroviaires. Construite par **Alstom entre 1967 et 1974**, la CC 72006 fait partie d’une série de locomotives puissantes (3 540 chevaux) conçues pour remplacer les locomotives à vapeur sur les lignes non électrifiées en France. Bien que la majorité des CC 72000 aient été retirées du service à la fin des années 2000, la CC 72006, avec sa livrée unique, reste un sujet de fascination pour les passionnés de trains, et sa réplique en modèle réduit est très prisée parmi les collectionneurs.



© Renaud Chodkowski

HJ2621



SNCF, locomotive diesel à 6 essieux CC 72056 « La Bourboule », livrée bleue avec logo « Casquette »

SNCF, 6-achs. dieselelektrische Mehrzwecklokomotive CC 72056 „La Bourboule“, blau-Farbgebung mit „Casquette“-Logo

SNCF, locomotiva diesel a 6 assi CC 72056 “La Bourboule”, livrea blu con logo “Casquette”

SNCF, locomotora diésel de 6 ejes CC 72056 “La Bourboule”, decoración azul con logotipo “Casquette”

SNCF, 6-axle diesel-electric locomotive CC 72056 “La Bourboule”, blue livery with “Casquette” logo

NEW



HJ2621

HJ4206HM-1

HJ4206HM-2

HJ4205-1



HJ4205-2

HJ4205-3

HJ4205-4

HJ4206HM-3

HJ2620



SNCF, locomotive diesel à 6 essieux CC 72006 « Isabelle », livrée bleue/argente/grise
SNCF, 6-achs. dieselelektrische Mehrzwecklokomotive CC 72006 „Isabelle“, in Blau/Silber/Grau Farbgebung
SNCF, locomotiva diesel a 6 assi CC 72006 “Isabelle”, livrea blu/argento/grigio
SNCF, locomotora diésel de 6 ejes CC 72006, decoración “Isabelle”, decoración azul/plata/gris
SNCF, 6-axle diesel-electric locomotive CC 72006 “Isabelle”, blue/silver/grey livery



À l'origine, les deux logos frontaux du CC 472006 ont été recouverts lorsqu'ils ont été peints dans la nouvelle livrée. Mais après seulement quelques semaines, l'un des logos a été perdu et n'a jamais été remplacé.

HJ2622



SNCF, locomotive diesel CC à 6 essieux 72084, livrée bleue avec logo « Carmillon »
SNCF, 6-achs. dieselelektrische Mehrzwecklokomotive CC 72084, blau-Farbgebung mit „Carmillon“-Logo
SNCF, locomotiva diesel a 6 assi CC 72084, livrea blu con logo “Carmillon”
SNCF, locomotora diésel de 6 ejes CC 72084, decoración azul con logotipo “Carmillon”
SNCF, 6-axle diesel-electric locomotive CC 72084, blue livery with “Carmillon” logo



CC 72084 est préservée et entretenue par l'AJECTA, une association française dédiée à la conservation du matériel ferroviaire historique. La locomotive est occasionnellement présentée lors d'expositions et d'événements spéciaux, permettant aux passionnés de chemin de fer d'apprécier cet exemple classique de l'ingénierie ferroviaire française.

NEW

NEW

Encore disponibles • Bereits lieferbar • Ancora disponibili • Aún disponibles • Still available

Les produits indiqués comme « déjà disponibles » pourraient être disponibles en quantité limitée ou déjà épuisés

Die als „bereits lieferbar“ gekennzeichneten Produkte könnten in begrenzter Menge verfügbar sein oder bereits ausverkauft sein

I prodotti segnalati come “ancora disponibili” potrebbero essere disponibili in quantità limitata o già esauriti

Los productos marcados como «aún disponibles» pueden estar disponibles en cantidad limitada o ya agotados

Products marked as “still available” may be available in limited quantity or already sold out

HJ2613

SNCF, autorail diesel EAD X 4697 + XR 8694, « Pays de la Loire », ép. V



- Prise pour décodeur DCC 21 broches (MTC)
- Longueur hors tampons 490 mm

HJ2614

SNCF, autorail diesel EAD X 4317 + XR 8517, livrée rouge/beige, ép. IV



- Aménagement intérieur
- Moteur avec volant d'inertie

HJ2615

SNCF, autorail diesel EAD XBD 4717 + XRABx 8714, livrée argent/bleue avec logo « Casquette », ép. IV-V

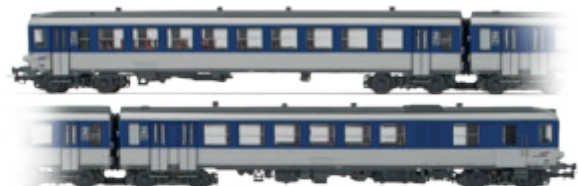

- Eclairage avec inversion blanc/rouge
- Attelage électrique entre les voitures motrices et de commande
- Attelages à elongation



Découvrez en détail la locomotive avec la vidéo de Bruno Miniature



 **HJ2616**

SNCF, autorail diesel X 3800 « Picasso », livrée rouge rubis/gris perle, ép. III



- Longueur hors tampons 245 mm
- Moteur avec volant d'inertie
- Eclairage avec inversion blanc et rouge



 **HJ2617**

SNCF, autorail diesel X 3800 « Picasso », livrée rouge/beige, ép. III



- Modification d'outillage
- Prise NEM pour décodeur NEM 660
- Longueur hors tampons : 245 mm
- Attelages à élancement
- Éclairage avec inversion blanc/rouge



 **HJ2619**

SNCF, autorail diesel X 93953 « Picasso », livrée bleu/beige, ép. IV





MKD2020

Villa avec garage - Kit
Wohnhaus mit Garage - Bausatz
Villa con garage - Kit
Villa con garaje - Kit
Terraced house with garage - Kit



MKD2021

Réparateur de tracteurs - Kit
Landmaschinenwerkstatt - Bausatz
Officina per macchine agricole - Kit
Taller de maquinaria agrícola - Kit
Agricultural machinery workshop - Kit



MKD2022

Clôtures de jardin
Gartenzäune
Recinzioni per giardino
Vallas de jardín
Garden Fences



MKD2023

BP Station-Service - Kit
Tankstelle - Bausatz
Stazione di servizio - Kit
Gasolinera - Kit
Service Station - Kit





Photo: Enrique Dopico

Índice • Index

Locomotoras diésel.....68

Diesel locomotives.....68

Locomotoras eléctricas.....72

Electric locomotives.....72

Coches de viajeros.....82

Coaches.....82

Vagones de mercancías.....88

Wagons.....88

Llegadas recientes.....92

Still available.....92



www.electrotren.com

Electrotren®

Entre las marcas del grupo Hornby que forman el catálogo 2025 el aficionado al modelismo ferroviario puede encontrar numeroso material de una gran variedad de administraciones ferroviarias y operadores europeos que permiten ampliar sus colecciones y variar el tráfico de su maqueta.

Para los aficionados al material ferroviario español Electrotren sigue siendo una referencia a nivel internacional, con una apuesta continua y centrada en los modelos de RENFE reproducidos con el mayor nivel de detalle y una gran variedad de versiones y decoraciones en sus modelos.

Los automotores eléctricos 444 en varias versiones ya estarán disponibles este año, junto los trenes de alta velocidad "AVLO" y el auscultador "SÉNECA".

Los coches 5000 con fuelles permitirán completar composiciones de todo tipo para los trenes de época IV, así como nuevas versiones de la impresionante dresina KLV. Queremos destacar el nuevo portacoches DDMA, de nuevo diseño totalmente español, que junto con otros vagones de mercancías ofrecen una amplia oferta de novedades completada con los modelos en stock que mostramos en este catálogo.

Las locomotoras 309 reproducidas cuentan con numerosos detalles de diseño y construcción:

- Motor con volante de inercia
- Placa de circuito impreso con conector E24 para decoder digital
- Chasis en metal
- Sonido con una excelente calidad de reproducción
- Discos de freno en los dos ejes extremos
- Luces blancas en el foco principal y focos inferiores
- Iluminación roja en luces traseras
- Luz en pupitre de conducción
- *esta función se puede encender y apagar de manera independiente en modo digital*
- Finas barandillas de metal fotograbado
- Los artículos con decoder digital están equipados con enganches funcionales y un Power Bank para mejorar la toma de corriente

LOCOMOTORA DE MANIOBRAS 309



HE2027/HE2027D/HE2027S

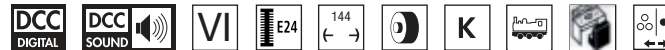

ADIF, locomotora diésel de maniobras serie 309, decoración verde/blanca

ADIF, Diesel-Rangierlokomotive der Reihe 309, grün/weiße Farbgebung

ADIF, locomotive diesel de manœuvre serie 309, livrée verte/blanche

ADIF, locomotiva diesel da manovra 309, livrea verde/bianca

ADIF, diesel shunting locomotive class 309, green/white livery

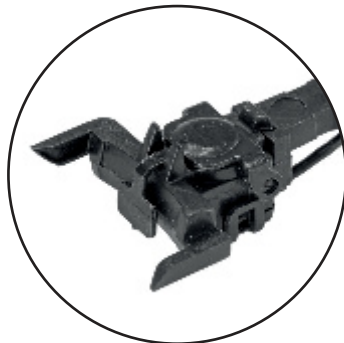

Enganches funcionales digitales



NEW

HE2028/HE2028D/HE2028S

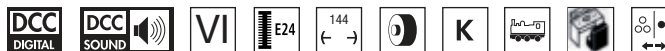

NEW



FESAVA, locomotora diésel de maniobras serie 309, decoración azul/gris

FESAVA, Diesel-Rangierlokomotive der Reihe 309, blau/grau Farbgebung

FESAVA, locomotive diesel de manœuvre serie 309, livrée bleue/grise

FESAVA, locomotiva diesel da manovra 309, livrea blu/grigia

FESAVA, diesel shunting locomotive class 309, blue/grey livery



Cabina detallada con maquinista

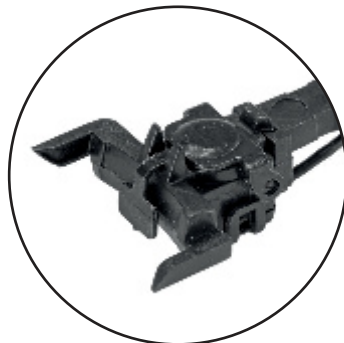

Enganches funcionales digitales



HE2029/HE2029D/HE2029S

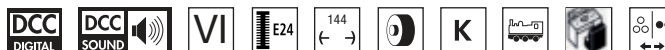

NEW



SRC, locomotora diésel de maniobras 312, decoración "Captrain" rojo-gris

SRC, Diesel-Rangierlokomotive 312, „Captrain“ rot-graue Farbgebung

SRC, locomotive diesel de manœuvre 312, livrée « Captrain » rouge-grise

SRC, locomotiva diesel da manovra 312, livrea "Captrain" rosso-grigia

SRC, diesel shunting locomotive 312, «Captrain» red-grey livery



Interior detallado con pupitre de conducción iluminado de manera independiente en todas las versiones

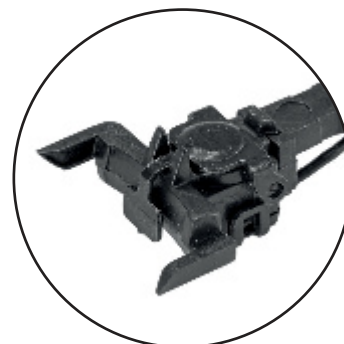

Enganches funcionales digitales



HE2010/HE2010D/HE2010S



RENFE, dresina KLV 53, decoración amarillo «Mantenimiento de Infraestructura»

RENFE, Rottenkraftwagen KLV 53 „Mantenimiento de Infraestructura“, gelber Farbgebung

RENFE, draisina KLV 53, livrée jaune «Mantenimiento de Infraestructura»

RENFE, draisina KLV, livrea gialla “Mantenimiento de Infraestructura”

RENFE, maintenance vehicle KLV 53, “Mantenimiento de Infraestructura” yellow livery



NEW

Versión de la carrocería con faros superiores



Fotomontaje / Photomontage / Fotomontage / Fotomontaggio



Lantas con discos de freno en cada rueda



Enganche magnético

Las KLV de Electrotren

Los pequeños trenes de trabajo formados por un vehículo motor y un pequeño remolque tienen su representación más conocida en las dresinas KLV 53 de Renfe.

Electrotren reproduce estos vehículos realizados con un elevado nivel de detalle y calidad, que incluyen luces, pluma móvil y versiones en formato analógico, digital y digital con sonido.

HE2011/HE2011D/HE2011S



NEW



ADIF, dresina KLV 53, decoración verde y blanco

ADIF, Rottenkraftwagen KLV 53, in grün-weißer Farbgebung

ADIF, draine KLV 53, livrée verte/blanche

ADIF, draisina KLV 53, livrea verde e bianca

ADIF, maintenance vehicle KLV 53, green/white livery



Fotomontaje / Photomontage / Fotomontage / Fotomontaggio

Características dresina KLV Electrotren

- Incluye detalles como focos, rejillas y escapes del motor dependiendo de la época y modelo
- Chasis metálico para peso adecuado, bajos detallados con discos y llantas de freno en todas las ruedas
- Pluma de carga móvil en todas direcciones y detallada
- Enganches magnéticos que permiten el paso de corriente
- Motor cinco polos con zócalo NEM 662 para el decoder digital
- Opción con sonido que incluye conversaciones con el puesto de mando



Pluma totalmente móvil

HE2015/HE2015S



NEW



RENFE, electrotrén basculante 443, con techo marrón y logos modernos

RENFE, Hochgeschwindigkeits-Neigezug Rh. 443, mit braunem Dach und modernem Logo

RENFE, coffret de 4 unités, automotrice électrique à assiette variable classe 443, avec toit marron et moderne logo

RENFE, set di 4 unità, elettrotreno ad assetto variabile ad alta velocità classe 443, con tetto marrone e logo moderno

RENFE, tilting high-speed EMU class 443, with brown roof and modern logo



EL PLATANITO

En septiembre de 1972 se estableció un convenio entre **RENFE** y **FIAT** para la construcción de un tren prototipo basculante de vía ancha, con opción de compra de 15 a 25 trenes si la experiencia resultaba satisfactoria. El tren debería constar de **cuatro coches**, todos ellos motores, con una velocidad máxima de 180 km/h. FIAT estableció un acuerdo con CAF que se encargó de la fabricación del tren en sus factorías de Beasain y Zaragoza, ocupándose cada una de ellas de un semi-tren de dos vehículos.

El tren completo fue entregado en 1976 y recibió la matrícula **443-001** y el sobrenombre de "**El Platanito**", debido a su decoración en **color amarillo con franjas marrones**. Inmediatamente, el tren empezó un largo periodo de pruebas en el marco de un ambicioso programa de investigación y desarrollo en el que se determinaron velocidades máximas e inclinaciones que alcanzaran hasta los ocho grados.

En 1979 comenzó su primer servicio comercial entre **Madrid y Albacete**, que pronto se extendió a la relación Madrid-Jaén, quedando de nuevo apartado a finales de 1982 con el sistema de basculación condenado por continuas averías que limitaban su velocidad. Dos años después volvió de nuevo a CAF para ser reacondicionado, adaptando sus convertidores y la decoración exterior, a la que se **modificó uno de los logos** de los extremos que había quedado obsoleto y se le añadió, a lo largo de todo el techo, una banda de pintura anticorrosiva de color pardo. Esta banda se realizó de manera diferente en cada uno de los coches extremos, a modo experimental. Además de ello, se volvieron a pintar los **pantógrafos de rojo**.

LAS CARACTERÍSTICAS TÉCNICAS DEL MODELO

- Enganches con conexión eléctrica entre coches
- Motor de cinco polos con volantes de inercia
- Chasis en metal para todos los coches
- Interior detallado
- Luces blancas o rojas en función del sentido de marcha
- Iluminación interior de los coches

- Conector MTC de 21 pins (NEM 660)
- Versiones digitales de sonido con decoder ESU LokSound V5
- Pantógrafos metálicos según época
- Longitud total 1.220 mm
- Rádio mínimo de giro 356,5 mm

El nuevo modelo de Electrotren

Esta última decoración es la nueva versión representada por **Electrotren**, con la referencia HE2015/HE2015S, incorporando todas estas diferencias y particularidades respecto a las referencias anteriormente fabricadas. A lo largo de su historia, el Electrotren Basculante recorrió gran parte de la red ferroviaria española electrificada, a lo largo de todos los puntos cardinales, alcanzando puntos tan dispares como Cádiz o Sevilla, Valencia y Barcelona o Gijón y Vigo, entre otros. Además, realizó algunos trenes turísticos como el “**Murallas de Ávila**” o el “**Doncel de Sigüenza**”, siendo finalmente retirado del servicio en septiembre de 1987. Se utilizó además en múltiples pruebas para los primeros estudios de alta velocidad, como la interacción de la catenaria, donde alcanzó la velocidad de 206 km/h., batiendo así el récord de aquel tiempo con tracción eléctrica.



2

Testero con distinta franja marrón

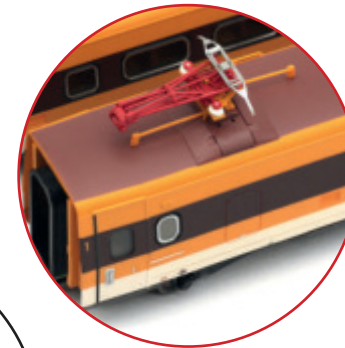

3

Pantógrafos en color rojo con frontador sencillo



1

Techos con diferente decoración



RENFE Serie 444



Los catorce trenes que formaron la serie 444 mejoraron respecto a la serie 432 en confort gracias a su nueva suspensión neumática e insonorización, contando con una mejor fiabilidad y nuevos interiores.

La imagen exterior de los nuevos trenes continuaba con el **color rojo** de base empleado en los trenes 432 sustituyendo las líneas plateadas por franjas amarillas que otorgaron a los 444 un aspecto único y llamativo entre los demás trenes de Renfe. La configuración de los trenes 444 estaba formada por un coche motor con cabina de conducción, furgón de paquetería y 72 plazas de segunda clase, un coche intermedio con 88 plazas de segunda clase y un remolque con cabina, cafetería y 52 plazas de primera clase.

Mecánicamente los 444 incorporaban los mismos bogies y motores de tracción que las unidades 440, con una **potencia total de 1.160 kW**, repartidos entre los cuatro motores del coche motor.

La alimentación de estos trenes era únicamente monofásica a 3 kv, a diferencia de los 432 bifásica 1.500 - 3.000 V. en clara adaptación a la eliminación de recorridos a 1.500v. que venía realizando Renfe.

El primer servicio prestado por los 444 fue el nuevo Intercity **entre Madrid y Valencia por Albacete** el 1 de junio de 1980, en un servicio creado para estos trenes y atendido por cuatro trenes en cada sentido diariamente. Uno de los servicios se prolongaba hasta Castellón. La velocidad media de este servicio era superior a los 100 km/h., ofreciendo comodidades como restauración para los viajeros de primera clase en su asiento incluido en el precio del billete, prensa, megafonía y servicio de azafatas.

El servicio prestado con estos trenes pronto se aplicó a otras relaciones donde comenzó a denominarse como servicio Electrotren, sobre nombre con el que serían conocidos estos magníficos trenes. Los nuevos servicios de largo recorrido encargados a los Electrotrenes 444 fueron Barcelona - Sevilla, Madrid - Sevilla y Barcelona - Málaga. La incorporación de nuevos Electrotrenes 444.500 permitió ampliar las relaciones Electrotren a Madrid - Zaragoza, Madrid - Alicante, Madrid - Hendaya, Madrid - Gijón, Barcelona - Irún, Barcelona - Gijón o Vigo - Hendaya, entre otros.



HE2020/HE2020D/HE2020S

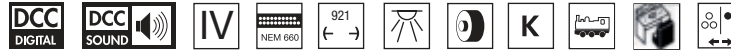

NEW



RENFE, automotor eléctrico serie 444, unidad 444-004, decoración rojo/amarillo

RENFE, elektrischer Triebzug der Reihe 444, Triebzug 444-004 in rot-gelber Farbgebung

RENFE, automotrice électrique classe 444, numéro d'immatriculation 444-004, livrée rouge/jaune

RENFE, elettromotrice serie 444, unità 444-004, livrea d'origine rossa/gialla

RENFE, 3-unit EMU class 444, unit 444-004 in original red/yellow livery

Pantógrafos metálicos



CARACTERÍSTICAS HE2020/D/S

- Versión de origen
- Testeros con puertas de intercomunicación
- Decoración rojo/amarillo
- Desde 1980 a 1993



Modelo 444 de Electrotren

- Chasis metálico en coche motor
- Motor de cinco polos
- Enganche Scharfenberg funcional en frontales
- Iluminación interior e iluminación en cabina
- Conector NEM660 21-pin MTC para decoder digital
- Interior detallado
- Luces blancas y rojas direccionales
- Radio de giro mínimo R1 356 mm
- Pantógrafos metálicos



Enganche frontal intercambiable,
decorativo



Enganche frontal intercambiable,
funcional



HE2021/HE2021D/HE2021S

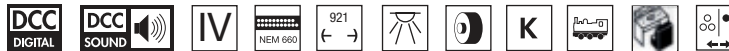

NEW



RENFE, automotor eléctrico serie 444.5, unidad 444-503, decoración "Estrella"

RENFE, elektrischer Triebzug der Reihe 444-500, Triebzug 444-503 in „Estrella“-Farbgebung

RENFE, automotrice électrique classe 444.5, numéro d'immatriculation 444-503, livrée « Estrella »

RENFE, elettromotrice serie 444.5, unità 444-503, livrea «Estrella»

RENFE, 3-unit EMU class 444-500, unit 444-503 in "Estrella" livery

CARACTERÍSTICAS HE2021

- Decoración "Estrella"
- Desde 1987 a 1994



Enganche frontal intercambiable, decorativo



Parte frontal fiel a la realidad, reproducida con todo detalle

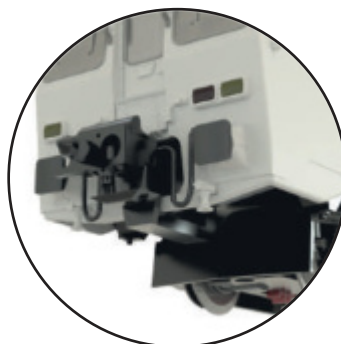

Enganche frontal intercambiable, funcional



I. Martín Yunta



HE2022/HE2022D/HE2022S

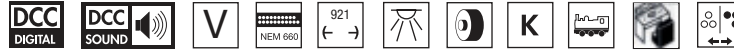

NEW



RENFE, automotor eléctrico serie 444, unidad 444-011, decoración azul/blanca

RENFE, elektrischer Triebzug der Reihe 444, Triebzug 444-011 in blau-weißer Farbgebung

RENFE, automotrice électrique classe 444, numéro d'immatriculation 444-011, livrée bleue/blanche

RENFE, elettromotrice serie 444, unità 444-011, livrea blu/bianca

RENFE, 3-unit EMU class 444, unit 444-011 in blue-white livery

CARACTERÍSTICAS HE2022

- Testeros con puertas de intercomunicación
- Decoración azul/blanco
- Desde 1990 a 1994



Eganche frontal intercambiable, decorativo



Pantógrafos metálicos



Eganche frontal intercambiable, funcional

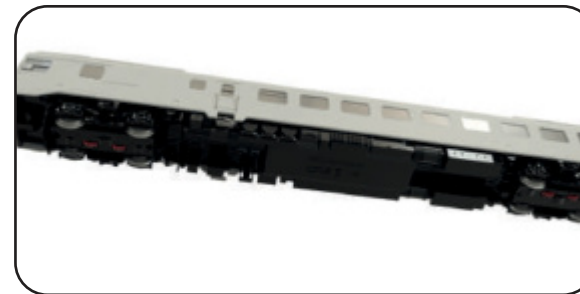

Chasis metálico para el coche motor



I. Martín Yunta



SERIE 112/330

AVE 112

Los trenes de la serie 112 son una evolución de los trenes serie 102 de RENFE. La principal diferencia afecta a su interior con la ampliación de plazas que llega hasta los 365 viajeros.

Algunas ramas han sido modificadas para el servicio AVLO suprimiendo su cafetería para obtener un total de 438 plazas en configuración turista, otros trenes han recibido la decoración AVLO sin modificaciones.

Tren Laboratorio “Séneca”

Este tren de la serie 330 de ADIF está formado por una cabeza motriz, tres coches intermedios y una cabeza con cabina de conducción pero sin motores. Este tren está diseñado para auscultación dinámica y geométrica de vía y catenaria, además de comprobación de los sistemas de señalización ASFA, ERTMS y GSM-R entre otras muchas comprobaciones que puede llevar a cabo este tren laboratorio.

CARACTERÍSTICAS TÉCNICAS:

- Chasis de metal en la cabeza tractora
- Motor de cinco polos con volantes de inercia
- Conector NEM 660, de 21 pines MTC, para decoder digital
- Pantógrafos metálicos y funcionales en modo digital
- Luces blancas y rojas independientes, según sentido de la marcha
- Radio mínimo 356 mm
- Cinemática de enganche corto entre locomotora y coches



HE2030/HE2030D/HE2030S



NEW

-  ADIF, tren de auscultación A330 "Séneca", decoración blanco-verde
- ADIF, Messzug A330 „Séneca“, weiß-grüne Farbgebung
- ADIF, train d'auscultation A330 « Séneca », livrée blanc-vert
- ADIF, treno diagnostico A330 "Séneca", livrea bianco-verde
- ADIF, Auscultation train A330 "Séneca", white-green livery



Pablo Nieto Abad



HE2031/HE2031D/HE2031S



NEW

-  **RENFE, set principal de 5 unidades del tren de alta velocidad "AVLO", decoración violeta**
- RENFE, 5-tlg. Grundset des Hochgeschwindigkeitszugs „AVLO“, violette Farbgebung
- RENFE, coffret principal de 5 unités du train à grande vitesse « AVLO », livrée violette
- RENFE, set di base di 5 unità del treno ad alta velocità "AVLO", livrea viola
- RENFE, 5-unit base set of the high-speed train "AVLO", purple livery



Marcos Maté



HE3001



RENFE, set complementario de 3 coches del tren de alta velocidad "AVLO", no. 1/3, decoración violeta

RENFE, 3-tlg. Ergänzungsset des Hochgeschwindigkeitszugs „AVLO“, Nr. 1/3, violette Farbgebung

RENFE, set complémentaire de 3 unités du train à grande vitesse « AVLO », no. 1/3, livrée violette

RENFE, set complementare di 3 unità del treno ad alta velocità "AVLO", no. 1/3, livrea viola

RENFE, 3-unit complementary set of the high-speed train "AVLO", no. 1/3, purple livery

NEW

HE3002



RENFE, set complementario de 3 coches del tren de alta velocidad "AVLO", no. 2/3, decoración violeta

RENFE, 3-tlg. Ergänzungsset des Hochgeschwindigkeitszugs „AVLO“, Nr. 2/3, violette Farbgebung

RENFE, set complémentaire de 3 unités du train à grande vitesse « AVLO », no. 2/3, livrée violette

RENFE, set complementare di 3 unità del treno ad alta velocità "AVLO", no. 2/3, livrea viola

RENFE, 3-unit complementary set of the high-speed train "AVLO", no. 2/3, purple livery

NEW

HE3003



RENFE, set complementario de 3 coches del tren de alta velocidad "AVLO", no. 3/3, decoración violeta

RENFE, 3-tlg. Ergänzungsset des Hochgeschwindigkeitszugs „AVLO“, Nr. 3/3, violette Farbgebung

RENFE, set complémentaire de 3 unités du train à grande vitesse « AVLO », no. 3/3, livrée violette

RENFE, set complementare di 3 unità del treno ad alta velocità "AVLO", no. 3/3, livrea viola

RENFE, 3-unit complementary set of the high-speed train "AVLO", no. 3/3, purple livery

NEW

COMPOSICIÓN DEL TREN / TRAIN COMPOSITION

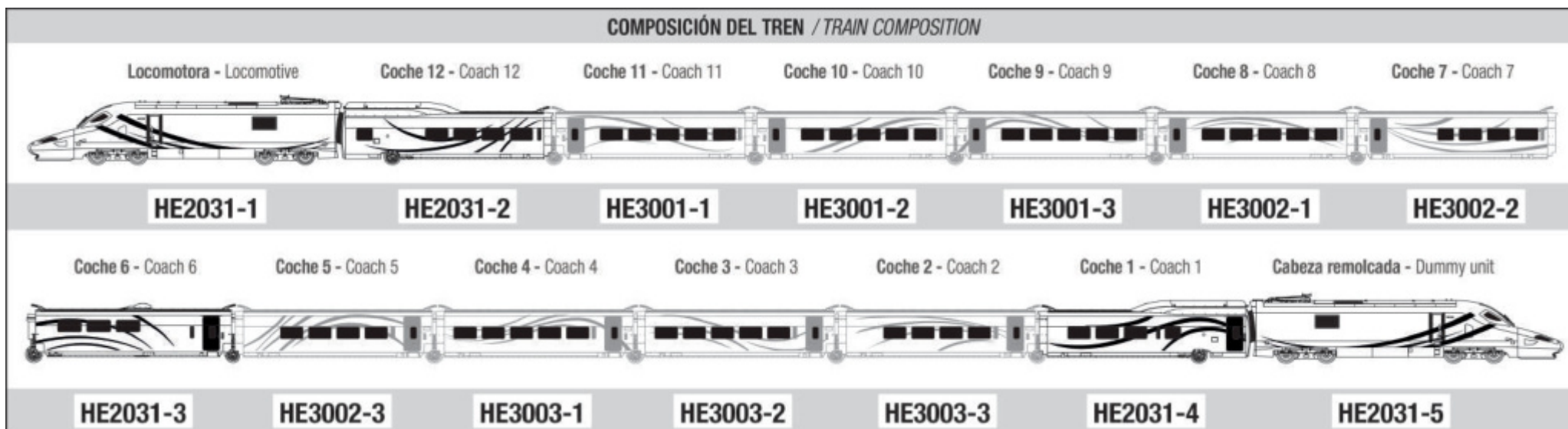

HE4037

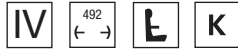

NEW



RENFE, set de 2 coches serie 5000, compuesto por 1 x furgón BBD4 + 1 x coche cafetería AAR, con fuelles, decoración verde oliva

RENFE, 2-tlg. Set Reisezugwagen 5000, 1 x BBD4 Gepäckwagen + 1 x AAR Barwagen, mit Faltenbälgen, olivgrüne Farbgebung

RENFE, coffret de 2 voitures série 5000, composé de 1 x BBD4 fourgon + 1 x AAR bar, avec soufflets d'origine, livrée vert olive

RENFE, set di 2 carrozze serie 5000, composto da 1 x BBD4 bagagliaio + 1 x AAR bar, con soffietti d'origine, livrea verde oliva

RENFE, 2-unit set of 5000 coaches, consisting of 1 x BBD4 baggage + 1 x AAR bar, with old bellows, in olive green livery

Ejes para sistema AC: HC6101 (11.27 x 24.25 mm)



Fotomontaje / Photomontage / Fotomontage / Fotomontaggio



HE2025

HE4037

HE4037

HE4038

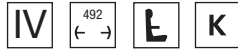

RENFE, set de 2 coches serie 5000, compuesto por 2 x BB4 de 2ª clase, con fuelles, decoración verde oliva
RENFE, 2-tlg. Set Reisezugwagen 5000 der Gattung BB4 2. Klasse, mit Faltenbälgen, olivgrüne Farbgebung
RENFE, coffret de 2 voitures série 5000, composé de 2 x BB4 de 2e classe, avec soufflets d'origine, livrée vert olive
RENFE, set di 2 carrozze serie 5000, composto da 2 x BB4 di 2ª classe, con soffietti d'origine, livrea verde oliva
RENFE, 2-unit set of 5000 coaches, consisting of 2 x BB4 2nd class, with old bellows, in olive green livery

NEW

Ejes para sistema AC: HC6101 (11.27 x 24.25 mm)



Fotomontaje / Photomontage / Fotomontage / Fotomontaggio



HE4038

HE4038

HE4042

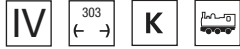

NEW



RENFE, plataforma autoexpreso DDMA, decoración gris, con rejillas antivandálicas

RENFE, 4-achs. Autotransportwagen der Gattung DDMA, graue Farbgebung, mit seittl. Schutzgittern

RENFE, fourgon porte-autos DDMA, livrée grise, avec grilles anti-vandalisme

RENFE, carro trasporto auto DDMA, livrea grigia, con griglie antivandalismo

RENFE, 4-axle car transporter type DDMA, in grey livery, with protective panels

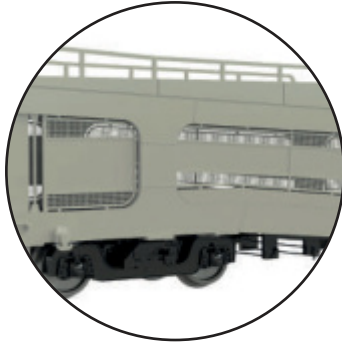

Rejillas en metal fotografado



Puntos destacados del nuevo modelo

- Nuevo molde
- Chasis en metal fundido a presión, que proporciona al vagón la estabilidad necesaria, con un centro de gravedad bajo y excelentes características de rodadura
- Bogies, topes, pasamanos, rejillas laterales y detalles específicos según la versión y la serie de vehículos reales
- Pasamanos de acero inoxidable para mayor robustez
- Chasis detallado, incluyendo las palancas del sistema de frenado
- Grabados finos y detallados en las chapas antideslizantes de las plataformas superior e inferior
- Mecanismos de enganche corto según la norma NEM 352 y cajetines de enganche según la norma NEM 362 en cada extremo
- Barras de sujeción para vehículos incluidas como piezas separadas



Photo: Jose Maria Martinez Cano

HE4043

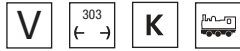

RENFE, plataforma autoexpreso DDMA, decoración blanca, con rejillas antivandálicas

RENFE, 4-achs. Autotransportwagen der Gattung DDMA, weiße Farbgebung mit seil. Schutzgittern

RENFE, fourgon porte-autos DDMA, livrée blanche, avec grilles anti-vandalisme

RENFE, carro trasporto auto DDMA, livrea bianca, con griglie antivandalismo

RENFE, 4-axle car transporter type DDMA, in white livery, with protective panels

NEW



HE4044

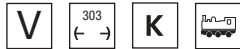

RENFE, vagón portacoches Uaks, decoración roja “Pecovasa”

RENFE, 4-achs. Autotransportwagen der Gattung DDMA, „Pecovasa“ in roter Farbgebung

RENFE, fourgon porte-autos Uaks, livrée rouge « Pecovasa »

RENFE, carro trasporto auto Uaks, livrea rossa “Pecovasa”

RENFE, 4-axle car transporter type DDMA, “Pecovasa” red livery

NEW



HE4027



NEW



CIWL, primer set de 3 coches "Sud-Expreso", compuesto de un coche DD3, un AA 5000 y un WL

CIWL, 3-teilige Zugpackung „Sud-Expreso“ (Set 1/2), bestehend aus DD3, AA 5000 + WL

CIWL, coffret de 3 voitures « Sud Express », set 1/2 (DD3, AA 5000 + WL)

CIWL, set di 3 carrozze "Sud-expreso", set 1/2 (DD3, AA 5000 + WL)

CIWL, 3-unit pack "Sud-expreso", set 1/2 (DD3 + AA 5000 green with stripes and bellows + WL)

Ejes para sistema AC: HC6101 (11.27 x 24.25 mm)

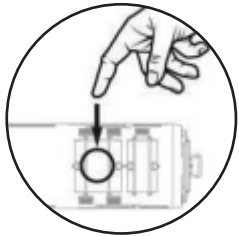

Coches equipados con iluminación interior con control táctil para activar y variar la intensidad

Un toque: Se enciende la luz en todos los compartimentos del coche cama.

Dos toques: Solo algunos compartimentos se iluminan.



Fotomontaje / Photomontage / Fotomontage / Fotomontaggio

HE4028



NEW



CIWL, segundo set de 3 coches "Sud-Expreso", compuesto de un coche VPC "Étoile du Nord" y dos WL

CIWL, 3-teilige Zugpackung „Sud-Expreso“ (Set 2/2), bestehend aus VPC Étoile du Nord + WL + WL

CIWL, coffret de 3 voitures « Sud Express », set 2/2 (VPC Étoile du Nord + WL + WL)

CIWL, set di 3 carrozze "Sud-expreso", set 2/2 (VPC Étoile du Nord + WL + WL)

CIWL, 3-unit pack "Sud-expreso", pack 2/2 (VPC Étoile du Nord + WL + WL)

Ejes para sistema AC: HC6101 (11.27 x 24.25 mm)

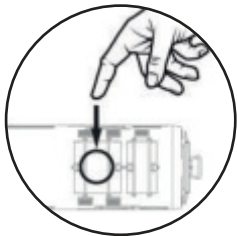

Coches equipados con iluminación interior con control táctil para activar y variar la intensidad

Un toque: Se enciende la luz en todos los compartimentos del coche cama.

Dos toques: Solo algunos compartimentos se iluminan.



Fotomontaje / Photomontage / Fotomontage / Fotomontaggio

HE6026

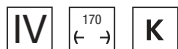

RENFE, vagón cisterna aislado de 4 ejes SALTRA para transporte de ácido cianhídrico, decoración gris-amarillo

RENFE, 4-achs. isolierter Kesselwagen SALTRA für den Transport von Blausäure, graue-gelbe Farbgebung

RENFE, wagon-citerne isolé à 4 essieux SALTRA pour le transport d'acide cyanhydrique, livrée gris-jaune

RENFE, carro cisterna a 4 assi SALTRA per il trasporto di acido cianidrico, livrea grigia-giallo

RENFE, 4-axle isolated tank wagon SALTRA for the transport of cyanhydric acid, in grey-yellow livery

NEW

Ejes para sistema AC: HC6100 (10.27 x 25,20 mm)



Fotomontaje / Photomontage / Fotomontage / Fotomontaggio



HE6072

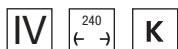

RENFE, set de 2 vagones cisterna PR para gas, decoración blanco-naranja "Butano S.A."

RENFE, 2-tlg. Set 2-achs. Gaskesselwagen, weiße-orange Farbgebung „Butano S.A.“

RENFE, coffret de 2 wagons-citernes à gaz, livrée blanc-orange « Butano S.A. »

RENFE, set di 2 carri cisterna trasporto gas, livrea bianca-arancio "Butano S.A."

RENFE, 2-unit set of 2-axle gas tank wagons, "Butano S.A." white-orange livery

NEW

Ejes para sistema AC: HC6104 (11.27 x 24.25 mm)



HE6073

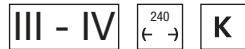

RENFE, set de 2 vagones cisterna PR de gas, decoración " Butano S.A. " plata-negro
RENFE, 2-tlg. Set 2-achs. Gaskesselwagen PR, „Butano S.A.“, silber-schwarze Farbgebung
RENFE, coffret de 2 wagons gaziers à 2 essieux PR, « Butano S.A. », livrée argent-noire
RENFE, set di 2 carri cisterna a 2 assi PR, "Butano S.A.", livrea argento-nera
RENFE, 2-unit pack of 2-axle gas tank wagons PR, "Butano S.A.", silver-black livery

Ejes para sistema AC: HC6101 (11.27 x 24.25 mm)



HE6070

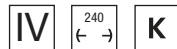

RENFE, set de 2 vagones cisternas PR de gas, decoración "Saltra" blanco-naranja
RENFE, 2-tlg. Set 2-achs. Gaskesselwagen Zgkk, „Saltra“ weiÙe-orange
RENFE, coffret de 2 wagons gaziers à 2 essieux PR, « Saltra » blanc-orange
RENFE, set di 2 carri cisterna a 2 assi per trasporto gas PR, "Saltra" bianca-arancio
RENFE, 2-unit pack of 2-axle gas tank wagons type Zgkk, "Saltra" white-orange

Ejes para sistema AC: HC6101 (11.27 x 24.25 mm)



HE6065

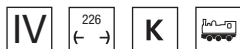

RENFE, vagón portacontenedores de 4 ejes MMC3, decoración rojo óxido, con contenedor de 40' "RENFE"

RENFE, 4-achs. Containerwagen MMC3, oxydrote Farbgebung, beladen mit 40' Container „RENFE“

RENFE, wagon porte-conteneurs à 4 essieux MMC3, livrée rouge oxyde, chargé avec un conteneur de 40' « RENFE »

RENFE, carro porta-container a 4 assi MMC3, livrea rosso ossido, caricato con container da 40' "RENFE"

RENFE, 4-axle container wagon MMC3, in oxid red livery, loaded with 40' container "RENFE"

NEW

Ejes para sistema AC: HC6100 (10.27 x 25,20 mm)



Fotomontaje / Photomontage / Fotomontage / Fotomontaggio

HE6080

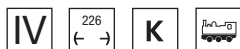

RENFE, vagón portacontenedores de 4 ejes MMC3, decoración rojo óxido, con contenedor frigorífico "Transporte Combinado"

RENFE, 4-achs. Containerwagen MMC3, oxydrote Farbgebung, mit Kühlcontainer „Transporte Combinado“

RENFE, wagon porte-conteneurs à 4 essieux MMC3, livrée rouge oxyde, avec conteneur frigorifique « Transporte Combinado »

RENFE, carro porta-container a 4 assi MMC3, livrea rosso ossido, con container refrigerante "Transporte Combinado"

RENFE, 4-axle container wagon MMC3, in oxid red livery, with refrigerator container "Transporte Combinado"

NEW

Ejes para sistema AC: HC6100 (10.27 x 25,20 mm)



HE6084

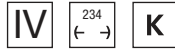

RENFE, vagón DDJP de 4 ejes "Paquete-Expres", con puertas intercambiadas, decoración plata-rojo óxido

RENFE, 4-achs. DDJP-Wagen „Paquete-Expres“, mit vertauschten Türen, silber-oxidrote Farbgebung

RENFE, wagon DDJP à 4 essieux « Paquete-Expres », avec portes échangées, livrée argent-rouge oxyde

RENFE, carro DDJP a 4 assi "Paquete-Expres", con porte invertite, livrea argento-rosso ossido

RENFE, 4-axle DDJP wagon "Paquete-Expres", with swapped doors, in silver-oxid red livery

NEW

Ejes para sistema AC: HC6100 (10.27 x 25,20 mm)



Fotomontaje / Photomontage / Fotomontage / Fotomontaggio

HE6086

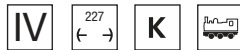

SNCF/RENFE, vagón lona de 4 ejes "Transfesa", decoración azul

SNCF/RENFE, 4-achs. Schiebeplanenwagen „Transfesa“, blaue Farbgebung

SNCF/RENFE, wagon bâché à 4 essieux « Transfesa », livrée bleue

SNCF/RENFE, carro telonato a 4 assi "Transfesa", livrea blu

SNCF/RENFE, 4-axle tarpaulin wagon "Transfesa", in blue livery

NEW

Ejes para sistema AC: HC6100 (10.27 x 25,20 mm)



Fotomontaje / Photomontage / Fotomontage / Fotomontaggio

HE6085

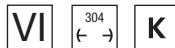

TRANSFESA/Hispanauto, vagón portacoques de 3 ejes Laeks "Mega Car Carrier", decoración azul con nuevo logo

TRANSFESA/Hispanauto, 3-achs. Autotransportwagen Laeks „Mega Car Carrier“, blaue Farbgebung mit neuem Logo

TRANSFESA/Hispanauto, wagon porte-autos à 3 essieux Laeks « Mega Car Carrier », livrée bleue avec nouveau logo

TRANSFESA/Hispanauto, carro trasporto auto a 3 assi Laeks "Mega Car Carrier", livrea blu con nuovo logo

TRANSFESA/Hispanauto, 3-axle car transporter Laeks "Mega Car Carrier", in blue livery with new logo

NEW

Ejes para sistema AC: HC6103



Fotomontaje / Photomontage / Fotomontage / Fotomontaggio



Photo: Enrique Dopico

Aún disponibles • Bereits lieferbar • Encore disponibles • Ancora disponibili • Still available

Los productos marcados como «aún disponibles» pueden estar disponibles en cantidad limitada o ya agotados

Die als „bereits lieferbar“ gekennzeichneten Produkte könnten in begrenzter Menge verfügbar sein oder bereits ausverkauft sein

Les produits indiqués comme « déjà disponibles » pourraient être disponibles en quantité limitée ou déjà épuisés

I prodotti segnalati come “ancora disponibili” potrebbero essere disponibili in quantità limitata o già esauriti

Products marked as “still available” may be available in limited quantity or already sold out



HE2006/HE2006D/HE2006S

RENFE, locomotora eléctrica clase 279, decoración «Taxi», ép. V



- Luces direccionales e independientes, incluido faros y luces de cabina
- Conector para decoder 21-pin MTC (NEM 660)
- Proyecto de sonido mejorado mediante decoder ESU LokSound V5
- Reproducción mejorada de detalles y características propias del modelo real
- Cajetín de enganche NEM 362
- Bastidor de metal
- Motor de cinco polos con dos volantes de inercia
- Longitud del modelo: 198 mm
- Radio mínimo: 356.5 mm



Photo: Enrique Dopico



HE2008

RENFE, dresina KLV 53, decoración amarillo, ép. IV



HE2009/HE2009D/HE2009S

RENFE, dresina KLV 53, decoración «Mantenimiento de Infraestructura», ép. VI



HE2016

RENFE, electrotrén basculante clase 443, con techo amarillo y logo antiguo, ép. Ivb



HE2017/HE2017S

RENFE, electrotrén basculante clase 443, versión de fábrica, ép. Iva



- Enchufe para receptor digital 21 pins (MTC)
- Modelo con iluminación interior y interiores detallados
- Motor con volante de inercia
- Con mecanismo para enganche corto
- Locomotora con luces reversibles blancas y rojas

HE2012/HE2012S

RENFE, locomotora de maniobras diésel 309, decoración «Estrella», ép IV



HE2013/HE2013S

RENFE, locomotora de maniobras diésel 309, decoración «Estrella Cargas RENFE», ép IV



HE2014

RENFE, locomotora de maniobras diésel 309, decoración roja/gris, ép V



- Un motor con volante de inercia
- Una placa de circuito impreso con conector Next 18 para decoder digital
- Chasis en metal
- Sonido con una excelente calidad de reproducción
- Los discos de freno en los dos ejes extremos
- Luces blancas en el foco principal y focos inferiores
- Iluminación roja en los pilotos traseros
- Pupitre de conducción en el interior de la cabina iluminado
**esta función se puede encender y apagar de manera independiente en modo digital*
- Finas barandillas de metal fotograbado
- La topera delantera se entrega totalmente decorada ya montada



 **HE2018/HE2018S**

RENFE, locomotora eléctrica clase 279, decoración verde/amarillo, ép. III



- Luces direccionales e independientes, incluido faros y luces de cabina
- Proyecto de sonido mejorado mediante decoder ESU LokSound V5
- Reproducción mejorada de detalles y características propias del modelo real
- Bastidor de metal
- Motor de cinco polos con dos volantes de inercia

 **HE2019/HE2019S**

MEDWAY, locomotora eléctrica 269 517-9, decoración negra/amarillo, ép. VI



HE2019

HE6063

HE6063

HE6064

HE6064



HE2023/HE2023S

RENFE, locomotora eléctrica 7501, edición del 80 aniversario, ép. III



- Los ejes motores de la locomotora se encuentran en dos ejes de cada bogie
- Cada grupo de ejes tiene un sistema de movimiento vertical desde el eje central, independiente del chasis y de los laterales del bogie
- Faro superior blanco, y luces inferiores blancas y roja según versión
- La parte móvil de los capots tiene una articulación completa de sus partes:



HE2024/HE2024S

NORTE, locomotora eléctrica 7206, versión Museo Vilanova y la Geltrú, decoración azul/roja



- El capot es solidario con la base rígida del bogie motor y gira junto a él en las curvas, independientemente de la caja de la locomotora
- El capot tiene un movimiento longitudinal que permite su separación de la caja, facilitando el giro en curvas de radio muy reducido
- El bogie portador bajo el capot tiene un movimiento de balancín en altura sobre su eje y un amplio margen de movimiento longitudinal respecto al eje de la vía



HE2025/HE2025S

RENFE, locomotora eléctrica 272-003 con franja amarilla, ép. IV



- El diseño de la locomotora permite un comportamiento eficiente en todo tipo de curvas y contracurvas, garantizando una excelente calidad de marcha y un gran efecto óptico
- Los laterales de los bogies están detallados, incluyendo la reproducción de tubos areneros y finas tuberías



Caja conmemorativa especial para el 80º aniversario de la 7501



Folleto sobre la historia de esta exitosa serie de locomotoras



Llavero metálico que reproduce la locomotora



 **HE4001**

RENFE, set de 2 furgones DD-8100, decoración rojo Paquexpres, ép. V



 **HE4013**

RENFE, set de 2 furgones postales DGDC-3000, decoración verde oliva, ép. III-IV



 **HE4015**

RENFE, set de 3 unidades, decoración verde oliva, compuesto de 1 coche 12100 y 2 vagones PMM (1 cargado con tanque), ép. V



 **HE4018**

ADIF, coche SSV-500 «Maquinaria de vía», decoración verde, ép. VI



 **HE4020**

RENFE, set de 3 coches «Costa Brava», decoración verde oliva, compuesto de 1 coche RRR-8000, 1 coche BB y 1 coche BBL, ép. IV



 **HE4021**

RENFE, set de 2 furgones postales P3-3100, con bogies GC para 160 km/h, decoración amarillo, ép. IV-V



HE4022

RENFE, furgón postal DGDC-3000, decoración verde con franjas amarillas, ép. III



HE4024

RENFE, coche cafetería AAR-5000, decoración «Estrella», ép. IV



- Nuevas versiones para los históricos coches tipo 5000 de Electrotren
- Todos los coches cuentan con carrocerías completamente nuevas, con techo integrado, representando las series AA (1ª clase), AAR (mixto 1ª clase-cafetería), BB4 (2ª clase, ex-3ª) y BBD4 (mixto 2ª clase-furgón, ex-3ª)
- Detallado de los testereros, con ganchos y mangueras de frenos en modo funcional o decorativo
- Aireadores para techos según subserie para cada versión, con diferentes tipos



HE4029

RENFE, coche B7r-6260, con fuelles, decoración "Regionales", ép. V



Electrotren ha reproducido varios ejemplares de estos vehículos a lo largo de su historia, siendo el más reciente el E5097. Sin embargo, en esta ocasión hemos reproducido por primera vez la variante de frontal original de estos coches, dotados con fuelles, bajo la referencia HE4029, el B7r-6260.

HE4030

RENFE, coche S-1033 "Manso", con fuelles, decoración "Regionales", ép. V



Electrotren fabricó recientemente el primero de ellos, en su versión con burletes, bajo la referencia E5096. Ahora ofrecemos la posibilidad de completar las composiciones incorporando el coche "Manso" restante, con matrícula S-1033, dotado de fuelles de intercomunicación. Una opción atractiva a la hora de representar esta particularidad de los enganches a escala puede ser el uso de los enganches magnéticos R7398 de Hornby, que representan fielmente el modelo americano.

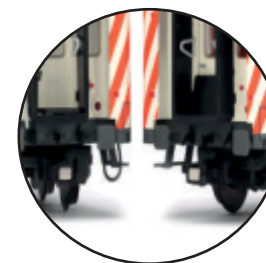

HE2005

E5096

E5097

E5028

HE4029

HE4030

Electrotren

HE4033

RENFE, coche BB-8937, de 2ª clase, con ventanas anchas, decoración "Estrella", ép. IV



- Carrocería de 2ª clase con ventanas anchas de 1,200 mm, de serie alta
- Primera vez que se fabrica en decoración "Estrella", sin reformar
- Ideal para complementar composiciones como el Expreso "Costa Brava"
- Enganche corto ajustable en longitud
- Topes funcionales



HE4031

ADIF, coche SSV-1041 "Tajo de Via", decoración verde/gris, ép. VI



HE4032

RENFE, coche PSSV "Herbicida", decoración verde/blanca, ép. V-VI



HE4035

RENFE, set complementario "Costa Brava, compuesto de un restaurante RRR-8000 en decoración azul-amarillo y dos literas BBL-8100 en decoración "Estrella", ép. IV



- Nuevo molde
- Longitud entre topes de 909 mm
- Modelo con interiores detallados
- Mecanismo elástico para enganche corto

HE4036

RENFE, set de 2 coches literas BBL-8100, decoración verde oliva, ép. IV



- Carrocerías y techos de nuevo molde para coches litera de 11 departamentos
- Interiores detallados, con literas y departamento del literista
- Escalerillas interiores de las literas en metal fotograbado
- Sets en decoración "Estrella", incluyendo restaurante con decoración época IV, y verde oliva, con ligeras diferencias entre coches
- Enganche corto ajustable en longitud
- Topes funcionales

 **HE6009**

R.N., set de 2 vagones cubiertos de 2 ejes PX, decoración gris, "Ensidesa", ép. III



 **HE6022**

RENFE, set de 2 vagones cisternas de 3 ejes, decoración gris, "Koipe", ép. IV



 **HE6024**

RENFE, set de 2 vagones cisternas de 3 ejes, decoración gris, "Elosua", ép. IV



 **HE6061**

NORTE, vagón para el transporte de vino, «V.M. Lecea - Vagones Cubas Madrid», ép. III



 **HE6051**

RENFE, set de 2 vagones cisternas de 3 ejes, «Saltra», ép. IV



 **HE6052**

RENFE, set de 2 vagones cisternas de 3 ejes, «Borges», ép. III



 **HE6062**

TRANSFESA, vagón articulado entoldado tipo Lails de 3 ejes, logo grande, ép. IV



- Lonas reproducidas con gran realismo
- Extremos e intermedios con numerosos detalles reproducidos
- Articulación central que garantiza una calidad de marcha óptima
- Mecanismo de enganche corto
- Reproducción exacta de la decoración según variantes



 **HE6063**

RENFE, vagón porta contenedores de 4 ejes MMC3, decoración azul, cargado con 2 contenedores para bobinas de 20' «Cadefer/Railsider», ép. VI



 **HE6064**

RENFE, vagón porta contenedores de 4 ejes MMC3, decoración azul, cargado con 2 coil-container de 20' «Tramesa», ép. VI



 **HE6068**

RENFE, vagón tolva de 4 ejes TT5 con paredes planas, decoración rojo oxido, «Metransa», ép. IV



 **HE6071**

RENFE, vagón cerrado tipo J2, decoración «Bultaco», ép. IV



Photo: Enrique Dopico

Photo: Enrique Dopico



Photo: Enrique Dopico

Índice • Index

Automotores diésel.....104

Diesel locomotives.....104

Llegadas recientes.....106

Still available.....106

Electrotren[®]
Hobby



www.electrotren.com

Esta gama destinada a la creación de modelos detallados con el mayor rigor posible y un precio muy ajustado dispone de un modelo verdaderamente interesante y bien realizado, como es el automotor diésel 596 "Tamagotchi". Este automotor se presenta con varias matrículas y decoraciones que permiten acoplar distintos automotores gracias a su acoplamiento "Scharfenberg" totalmente funcional. El automotor cuenta con luces blancas y rojas según el sentido de la marcha y un funcionamiento perfecto.

HE2501A



RENFE, automotor diesel 596-003, decoración "Media Distancia"

RENFE, Dieseltriebwagen 9-596-003-4, in „Media Distancia“-Farbgebung

RENFE, autorail diesel 9-596-003-4, livrée « Media Distancia »

RENFE, automotrice diesel 9-596-003-4, livrea "Media Distancia"

RENFE, diesel railcar 9-596-003-4, "Media Distancia" livery



Enganche Scharfenberg



HE2501B



RENFE, automotor diesel 596-005, decoración "Media Distancia"

RENFE, Dieseltriebwagen 9-596-005-9, in „Media Distancia“-Farbgebung

RENFE, autorail diesel 9-596-005-9, livrée « Media Distancia »

RENFE, automotrice diesel 9-596-005-9, livrea "Media Distancia"

RENFE, diesel railcar 9-596-005-9, "Media Distancia" livery



Enganche funcional



HE2503

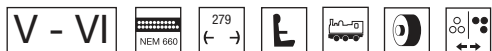

RENFE, automotor diesel 596-004, decoración "Regionales R2" con logo moderno
RENFE, Dieseltriebwagen 9-596-004-2 in „Regionales R2“-Farbgebung mit neuem Logo
RENFE, autorail diesel 9-596-004-2, livrée « Regionales R2 » avec nouveau logo
RENFE, automotrice diesel 9-596-004-2, livrea "Regionales R2" con logo nuovo
RENFE, diesel railcar 9-596-004-2, "Regionales R2" livery with new logo

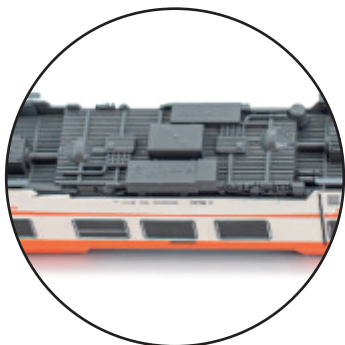

Bajos detallados



HE2505

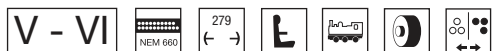

RENFE, automotor diesel 596-006, decoración blanca
RENFE, Dieseltriebwagen 9-596-006-7 in weißer Farbgebung
RENFE, autorail diesel 9-596-006-7, livrée blanche
RENFE, automotrice diesel 9-596-006-7, livrea bianca
RENFE, diesel railcar 9-596-006-7, white livery



Interior con detalle



Aún disponibles • Bereits lieferbar • Encore disponibles • Ancora disponibili • Still available

Los productos marcados como «aún disponibles» pueden estar disponibles en cantidad limitada o ya agotados

Die als „bereits lieferbar“ gekennzeichneten Produkte könnten in begrenzter Menge verfügbar sein oder bereits ausverkauft sein

Les produits indiqués comme « déjà disponibles » pourraient être disponibles en quantité limitée ou déjà épuisés

I prodotti segnalati come "ancora disponibili" potrebbero essere disponibili in quantità limitata o già esauriti

Products marked as "still available" may be available in limited quantity or already sold out

HE2500A

RENFE, automotor diesel 596, decoración "Regionales R1", 9-596-006-7, ép. V



HE2502A

RENFE, automotor diesel 596, decoración "Regionales R2", 9-596-001-8, ép. V



HE2504A

RENFE, automotor diesel 596, decoración «Media Distancia», 9-569-005-9, ép. VI



 **HE2500B**

RENFE, automotor diesel 596, decoración "Regionales R1", 9-596-003-4, ép. V



 **HE2502B**

RENFE, automotor diesel 596, decoración "Regionales R2", 9-596-002-6, ép. V



 **HE2504B**

RENFE, automotor diesel 596, decoración «Media Distancia», 9-569-003-4, ép. VI





Photo: Carlo Tagliaferri

Indice • Index

Locomotive a vapore.....110

Steam locomotives.....110

Locomotive diesel.....120

Diesel locomotives.....120

Locomotive elettriche.....128

Electric locomotives.....128

Carrozze.....141

Coaches.....141

Carri.....153

Wagons.....153

Ancora disponibili165

Still available.....165



www.rivarossi.com

Rivarossi®

Rivarossi celebra nel 2025 i suoi primi 80 anni di vita: il marchio riferimento del fermodellismo italiano non sembra però subire gli effetti dell'età, anzi, punta a ringiovanirsi con nuove proposte sempre al passo coi tempi. L'anniversario viene simbolicamente celebrato con un modello speciale, che unisce la tradizione del passato con la modernità delle ferrovie attuali, come potrete scoprire nelle pagine successive.

Questo nuovo catalogo propone un'ampia scelta di modelli, che vanno a consolidare la produzione ed i nuovi annunci degli anni precedenti: vi sono quindi le locomotive a vapore Gr. 685 e le locomotive elettriche E656/E655 delle FS interamente riprogettate secondo gli standard qualitativi odierni, che vedranno finalmente la luce quest'anno - da sottolineare che nel 2025 cade anche il 50esimo anniversario del "Caimano", degnamente celebrato con una nuova versione speciale -, ma vi è anche il rifacimento integrale di un altro modello storico Rivarossi, ovvero la locomotiva a vapore carenata 61 001 delle DRG per l'"Henschel-Wegmann" completo di carrozze, oltre ovviamente a numerose nuove versioni inedite di modelli prodotti negli anni precedenti.

Anche per il materiale rimorchiato si amplia la produzione di carrozze CIWL ed UIC-X in versioni non riprodotte in precedenza; teniamo sempre d'occhio l'evoluzione delle ferrovie reali e quindi proponiamo le nostre Gran Confort e Z1 ristrutturate nelle nuovissime livree Intercity ed Intercity Notte di Trenitalia, insieme ad una vasta selezione di carri merci di diverse tipologie ed amministrazioni, per tutti i gusti.

FS Gr. 685



Photo: Carlo Tagliaferri

Le locomotive del **Gruppo 685** sono la versione a vapore surriscaldato e a semplice espansione della precedente serie di locomotive del gruppo 680 delle Ferrovie dello Stato di cui ricalcano l'impostazione meccanica generale e le dimensioni. Furono costruite su progetto dell'Ufficio Studi di Firenze delle FS in 241 esemplari con distribuzione Walschaerts e 30 con distribuzione a valvole sistema Caprotti (queste ultime inizialmente classificate nel gruppo 686), entrate in servizio a partire dal 1912.

Successivamente, tra il 1921 e il 1930 iniziò la trasformazione in 685 di un consistente quantitativo di locomotive 680 che diede origine alle serie 685.300 (con distribuzione Walschaerts) e 685.500 (con distribuzione Caprotti). Tra il 1931 e il 1934 un ulteriore gruppo di 50 unità 680 venne trasformato mediante l'applicazione della distribuzione Caprotti, di un surriscaldatore e di un preriscaldatore Knorr dando luogo al sottogruppo S.685.

La locomotiva 685 rappresenta senz'altro il compendio della massima espressione tecnologica italiana legata alla trazione ferroviaria a vapore e non a caso questa macchina, che in mani esperte era capace di regalare ottime prestazioni, venne affettuosamente ed informalmente ribattezzata "**La Regina**". Le unità del gruppo prestarono un importante servizio attivo fino agli anni '60.

Rivarossi riproduce unità della prima serie (numerazioni da 685 001 a 066) e della seconda serie (da 685 067 a 106), caratterizzate dalla prima versione "corta" della caldaia, riproducendo fedelmente tutte le differenze presenti tra le due serie.

HR2914/HR2914S

HMDCC



NEW



FS, locomotiva a vapore Gr. 685, 2ª serie, con caldaia corta e fanali a petrolio

FS, Schleppdampflok mit Schlepptender Gr. 685, 2. Serie, mit kurzem Kessel und Öllampen

FS, locomotive à vapeur Gr. 685, 2^{ème} série, avec chaudière courte et lampes à huile

FS, locomotora de vapor Gr. 685, segunda serie, con caldera corta y luces de petroleo

FS, express train steam locomotive with tender Gr. 685, 2nd series, with short boiler and oil lamps



Fanali a petrolio funzionanti
e respingenti moderni



Campione non definitivo

Il nuovissimo modello Rivarossi nei punti chiave

- Riproduzione in perfetta scala H0 1:87 delle unità di prima e seconda serie con caldaia corta
- Tender FS a carrelli da 22 m³ interamente di nuova costruzione
- Interfaccia 21MTC (NEM 660) per decoder digitale nel tender
- Predisposizione per impianto sonoro con due altoparlanti "sugar cube" nel tender
- Telaio, ruote e caldaia in metallo pressofuso
- Telaio finemente riprodotto e dettagliato, con struttura "aperta"
- Riproduzione funzionante delle bielle motrici interne al telaio
- Ruote motrici con bordino ribassato a norme NEM 311.1 e razze in scala
- Cinematismo di allontanamento tra macchina e tender, con condotta elettrica e regolabile in lunghezza
- Portagancio NEM 362 con timone di allontanamento sulla testata posteriore del tender

- Possibilità di installazione del gancio modellistico a norma NEM 363 sulla testata anteriore della macchina
- Riproduzione completa della cabina di guida, con illuminazione interna
- **Forno illuminato (DC) o scoppiettante (in digitale)**
- Fanali anteriori a petrolio o elettrici in base alla versione, entrambi illuminati
- Fanali posteriori sul tender presenti su alcune versioni, riproduzione delle lanterne di coda opzionali
- Raggio minimo di curvatura: 420 mm

- Con forno scoppiettante
- Mit flackerner Feuerbüchse
- Avec boîte à feu scintillant
- Con luz en la caja de fuegos
- With flickering firebox

Valido per tutte le Gr.685



HR2915/HR2915S

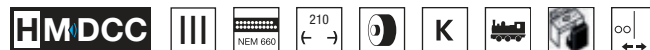

NEW

 **FS, locomotiva a vapore Gr. 685, 1ª serie, con caldaia corta e fanali elettrici**
FS, Schleppdampflok mit Schlepptender Gr. 685, 1. Serie, mit kurzem Kessel und elektrischen Lampen
FS, locomotive à vapeur Gr. 685, 1^{ère} série, avec chaudière courte et phares électriques
FS, locomotora de vapor Gr 685, primera serie, con caldera corta y lámparas eléctricas
FS, express train steam locomotive with tender Gr. 685, 1st series, with short boiler and electric lamps



Fanali elettrici funzionanti e respingenti a bovolo



Dettagli specifici per unità di prima serie a fine carriera



Campione non definitivo



Photo: Carlo Tagliaferri



HR2915

HR4365-1

HR4365-2

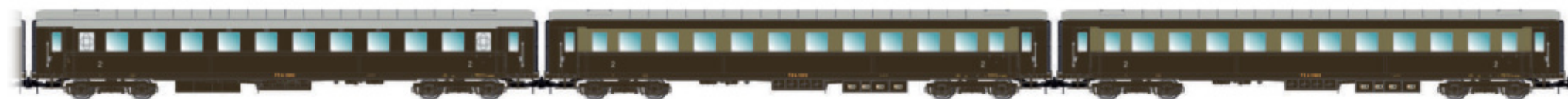

HR4365-3

HR4367-1

HR4367-2

HR2916/HR2916S

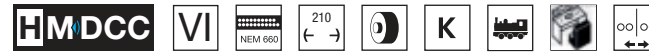

NEW



FS, locomotiva a vapore Gr. 685 089, 2ª serie, con caldaia corta, locomotiva storica
FS, Schleppdampflokomotive mit Schlepptender Gr. 685 089, 2. Serie, mit kurzem Kessel, Museumslokomotive
FS, locomotive à vapeur Gr. 685 089, 2^{ème} série, avec chaudière courte, locomotive historique
FS, locomotora de vapor Gr. 685 089, segunda serie, con caldera corta, locomotora histórica
FS, express train steam locomotive with tender Gr. 685 089, 2nd series, with short boiler, historic locomotive



Campione non definitivo



Tender con sopralzo carboniera e chiodature aggiuntive



Vomere ripiegabile frontale, fanali elettrici funzionanti



HR2916

HR4369-1

HR4369-2

HR4369-3

HR2892/HR2892S

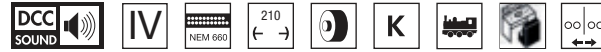

NEW



DB, locomotiva a vapore 055 632-4, livrea nera/rossa

DB, Dampflokomotive mit Schlepptender 055 632-4, in schwarz-roter Farbgebung

DB, locomotive à vapeur 055 632-4, livrée noire/rouge

DB, locomotora de vapor 055 632-4, decoración negro/rojo

DB, steam locomotive with tender 055 632-4, black/red livery



Feinste Detaillierung
entsprechend des Vorbilds

- Con forno scoppiettante
- Mit flackerner Feuerbüchse
- Avec boîte à feu scintillant
- Con luz en la caja de fuegos
- With flickering firebox



HR2893/HR2893S

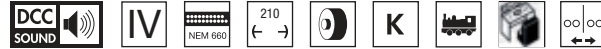

NEW



DR, locomotiva a vapore 55 7254, livrea nera/rossa

DR, Dampflokomotive mit Schlepptender 55 7254, in schwarz-roter Farbgebung

DR, locomotive à vapeur 55 7254, livrée noire/rouge

DR, locomotora de vapor 55 7254, decoración negro/rojo

DR, steam locomotive with tender 55 7254, black/red livery



Das brandneue Rivarossi-Modell in Stichpunkten

- Feine Detaillierung entsprechend des Vorbildes
- Viele separat angesetzte Details
- Modell größtenteils aus Metall
- Feine Speichenradsätze aus Metallspritzguss
- Signalbeleuchtung mit der Fahrtrichtung wechselnd
- Mit flackernder Feuerbüchse
- Bestellnummern, welche mit "S" enden, sind ab Werk digital mit Sound ausgestattet
- Kurzkupplungskinematik an Lok und Tender
- Mindestradius: 356,5 mm

- Con forno scoppiettante
- Mit flackernder Feuerbüchse
- Avec boîte à feu scintillant
- Con luz en la caja de fuegos
- With flickering firebox





17

Stromlinienzug
mit Dampflokomotive für 170 km Std.

17

Stromlinienzug
mit Dampflokomotive für 170 km Std.

17

Stromlinienzug
mit Dampflokomotive für 170 km Std.

17

Stromlinienzug
mit Dampflokomotive für 170 km Std.

61 001

*Sammlung Andreas Knipping,
aus „Die Reichsloks 61“ vom EK-Verlag*

Henschel-Wegmann-Zug

Die Übergabe der Lokomotive fand am 31. Mai 1935 statt. Zugelassen war sie für eine Geschwindigkeit von bis zu 175 km/h, die mit den 2.300 Millimeter großen Treibrädern auch erreicht wurden, allerdings unter starken Zuckbewegungen, die auf das Zwei-Zylinder-Triebwerk zurückzuführen waren und sich sogar auf den Zug übertrugen. Man wollte daher der Lok keine Fahrplangeschwindigkeiten von bis zu 160 km/h zumuten und setzte deshalb diesen Stromlinienzug im Planverkehr zwischen Berlin und Dresden ein, wo die Höchstgeschwindigkeit damals bei 135 km/h lag.

Die nach vorn abgeschrägtem Wasserbehälter gewährten Lokführer und Heizer eine rundum gute Streckensicht. Der „Blechmantel“, so die amtliche Beschreibung, verkleidete das Triebwerk komplett. Hier ist der Zug bei der Ausstellung zur Hundertjahrfeier der deutschen Eisenbahnen in Nürnberg zu sehen.

HR2953/HR2953S

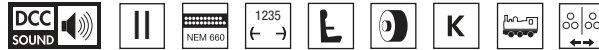

NEW



DRG, locomotiva a vapore ad alta velocità 61 001, livrea definitiva con treno Henschel-Wegmann (4 carrozze)

DRG, Stromliniendampflokomotive 61 001 in endgültiger ep. mit vierteiligem Henschel-Wegmann-Zug

DRG, locomotive à vapeur à grande vitesse 61 001, livrée définitive avec train Henschel-Wegmann (4 voitures)

DRG, locomotora de vapor de alta velocidad 61 001, decoración final con Henschel-Wegmann-Zug

DRG, high-speed steam locomotive 61 001, final livery with Henschel-Wegmann train (4 coaches)



Fotomontaggio / Fotomontage / Photomontage / Fotomontaje

Der **Henschel-Wegmann-Zug** wurde zunächst auf der Ausstellung zum 100-jährigen Bestehen der Deutschen Eisenbahnen vom 14. Juli bis 13. Oktober 1935 in Nürnberg ausgestellt und ging dann zur weiteren Bearbeitung nach Kassel. Mit Inkrafttreten des Sommerfahrplans 1936 befuhr die Henschel-Wegmann-Zug die Strecke Berlin – Dresden mit zwei Zugpaaren pro Tag. Dabei benötigte er für ein Strecke eine Stunde und 40 Minuten und übertraf damit den bisherigen Rekord um 28 Minuten, ein Rekord, der bis heute Bestand hat. In den offiziellen Berechnungen maß die Reichsbahn ihre Geschwindigkeit nur zwischen Berlin und der Dresdner Neustadt und vernachlässigte damit die letzten Kilometer bis zum Dresdner Hauptbahnhof. So konnte die Durchschnittsgeschwindigkeit des Zuges mit 111,2 km/h angegeben werden. Die kurze Wendezeit in Dresden zwischen den Verbindungen D 54 und D 57 war offensichtlich recht knapp.

Wie sich herausstellte, musste die Lokomotive nicht nur um den Zug herumfahren, sondern auch ihre Vorräte auffüllen. Zum Glück musste sie nicht zusätzlich noch auf der Drehscheibe gedreht werden. Dieses Wendezeitproblem wurde von der Reichsbahn im Winterfahrplan 1936 behoben.

Das neue Rivarossi-Modell im Detail

- Vollständige Neukonstruktion
- Viele angesetzte Details, größtenteils aus Metall
- Feine Speichenradsätze aus Metallspritzguss
- Spitzenbeleuchtung mit der Fahrtrichtung wechselnd
- Bestellnummern, die mit „S“ enden, sind ab Werk mit Sound ausgestattet
- Kurzkupplungskinematiken an beiden Enden der Lokomotive
- Mindestradius: 356,5 mm

Die Henschel-Wegmann-Zuggarnitur sollte in Konkurrenz zu den Dieseltriebwagen, die an den jeweiligen Endbahnhöfen einen schnellen Richtungswechsel erlaubten, fahren. Es war daher beabsichtigt, möglichst auf zeitraubende Prozeduren, wie beispielsweise das bei Schlepptender-Schnellzuglokomotiven in aller Regel notwendige Wenden auf einer Drehscheibe, zu verzichten. Hieraus leitete sich ab, dass die Lokomotive der Zuggarnitur in beide Fahrrichtungen mit der gleichen Höchstgeschwindigkeit fahren können sollte, weshalb man sie als Tenderlokomotive ausführte.

Um die vorgesehenen Fahrleistungen erzielen zu können, wurde die Lokomotive ebenso wie die Wagen besonders leicht ausgelegt; die Kohle- und Wasservorräte bemaß man gerade ausreichend für eine einfache Fahrt auf der vorgesehenen Strecke.

Mit den 2,30 Meter durchmessenden Treibrädern erreichten die Lokomotiven ohne unzulässig hohe Triebwerks-Drehzahlen und Kolbengeschwindigkeiten die vorgesehene Höchstgeschwindigkeit von 175 km/h problemlos; die Lok 61 001 schaffte bei Versuchsfahrten eine maximale Geschwindigkeit von 185 km/h. Mit dem Stromlinienzug wurde aber nur Tempo 130 gefahren. Der Plandienst zwischen Dresden und Berlin wurde erfolgreich durchgeführt, die 176 Kilometer lange Strecke in nur 102 Minuten bewältigt, eine Zeit, die auf dieser Strecke bis heute (2011) trotz schnellerer Elektrolokomotiven nicht unterboten wurde.

Recht knapp bemessen war dabei die Aufenthaltszeit des Zuges in Dresden, da die Lok nicht nur an das andere Zugende umsetzen, sondern infolge der knapp bemessenen Vorräte auch noch diese erneuert werden mussten.

Bei einem Ausfall der Lok 61 001 oder der Wagengarnitur wegen planmäßiger oder außerplanmäßiger Arbeiten setzte man eine Lok der Baureihe 01 oder Baureihe 03 ein.

Mit 130 km/h erreichten sie die Höchstgeschwindigkeit der 61 001 jedoch nicht.

Nach Einstellung des Zugbetriebes bei Kriegsbeginn 1939 wurde die 61 001 zum Heizdienst in Bahnbetriebswerk Berlin-Grunewald eingesetzt. Ab Dezember 1940 befand sie sich wieder in Dresden-Altstadt im Schnellzugdienst und erhielt im November 1942 konventionelle Zug- und Stoßvorrichtungen.

Auch die auffällige Farbgebung wurde durch grau ersetzt. Später wurde auch der untere Teil der Verkleidung entfernt, damit das Triebwerk besser zugänglich war. Die Betriebsprotokolle weisen nur geringe Laufleistungen aus. Von 1943 bis Kriegsende war das Ausbesserungswerk Braunschweig für die Lok zuständig. Zwischen Juli 1945 und März 1946 legte sie rund 40.000 Kilometer vor Personenzügen zurück.

Deutsche Reichsbahn

61 001

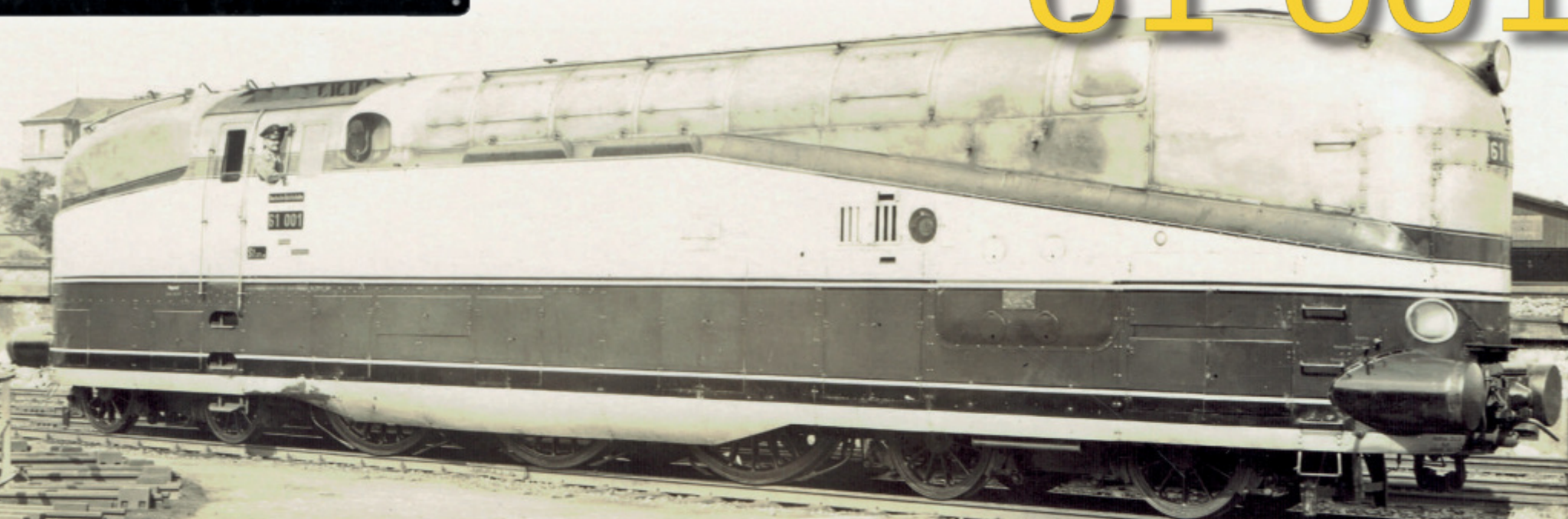

HR2954/HR2954S



DRG, locomotiva a vapore ad alta velocità 61 001, livrea rossa

DRG, Stromliniendampflokomotive 61 001 in roter Farbgebung

DRG, locomotive à vapeur à grande vitesse 61 001, livrée rouge

DRG, locomotora de vapor de alta velocidad 61 001, decoración roja

DRG, high-speed steam locomotive 61 001, red livery

NEW



Fotomontaggio / Fotomontage / Photomontage / Fotomontaje

HR2955/HR2955S

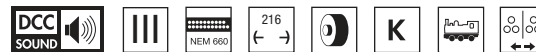

DB, locomotiva a vapore ad alta velocità 61 001, livrea nera con strisce

DB, Stromliniendampflokomotive 61 001 in schwarzer ep. mit Zierstreifen

DB, locomotive à vapeur à grande vitesse 61 001, livrée noire avec rayures

DB, locomotora de vapor de alta velocidad 61 001, decoración negro con franjas

DB, high-speed steam locomotive 61 001, black with stripes

NEW



Fotomontaggio / Fotomontage / Photomontage / Fotomontaje

HR2990/HR2990D/HR2990S



NEW



DB, draisina KLV 53, livrea gialla

DB, Rottenkraftwagen KLV 53 in gelber Lackierung

DB, draisine KLV 53, livrée jaune

DB, dresina KLV 53, decoración amarillo

DB, maintenance vehicle type KLV 53, yellow livery



Magnetkupplung

Fotomontaggio / Fotomontage / Photomontage / Fotomontaje



Fein detaillierte Kabine

Das Rivarossi-Modell im Detail

- Feine Speichenradsätze aus Metallspritzguss
- Frei beweglicher Kran am Heck des KLV
- Spitzenbeleuchtung mit der Fahrtrichtung wechselnd (nicht bei allen Modellvarianten)
- 18-polige Digitalschnittstelle nach NEM 662
- Bestellnummern, die mit „D“ enden, sind ab Werk mit Digitaldecoder ausgestattet
- Bestellnummern, die mit „S“ enden, sind ab Werk mit Sound ausgestattet
- Stromführende Magnetkupplung zwischen KLV und Anhänger

HR2925/HR2925D/HR2925S



NEW



DBG, draisina KLV 53, livrea giallo/blu

DBG, Rottenkraftwagen KlV 53 in gelb-blauer Farbgebung

DBG, draisine KLV 53, livrée jaune/bleue

DBG, dresina de mantenimiento tipo KlV 53, decoración amarillo/azul

DBG, maintenance vehicle KLV 53, yellow/blue livery



Photo : Stefan Kunzmann

HR2988/HR2988S



NEW



BASF, locomotiva diesel-elettrica Vossloh DE 18, livrea arancio/grigio

BASF, dieselelektrische Lokomotive Vossloh DE 18, orange/grau

BASF, locomotive diesel-électrique Vossloh DE 18, livrée orange/gris

BASF, locomotora diésel-eléctrica Vossloh DE 18, librea naranja/gris

BASF, Vossloh DE 18 diesel-electric locomotive, orange/grey livery



Fotomontaggio / Fotomontage / Photomontage / Fotomontaje

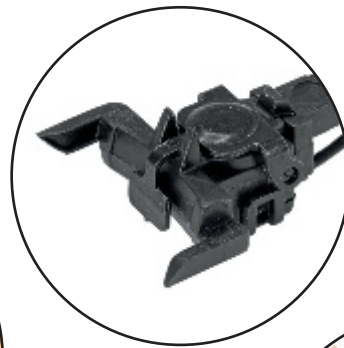

Das Rivarossi-Modell im Detail

- Neu mit fernsteuerbaren Digitalkupplungen an beiden Enden der Lok (Artikel HR2988S)
- Neuer, fünfpoliger Hochleistungsmotor mit Schwungmassen
- Monitore im Führerpult beleuchtet
- Innenbeleuchtung im Führerhaus
- Chassis aus Zinkdruckguss, Gehäuse auch hochwertigem, fein graviertem Kunststoff
- Alle vier Achsen angetrieben
- Stromabnahme über alle Räder der Lokomotive
- Spitzenbeleuchtung mit der Fahrtrichtung wechselnd
- Kurzkupplungskulissen beidseitig

HR2989/HR2989S



NEW



DB Cargo, locomotiva diesel-elettrica Vossloh DE 18, livrea rosso/grigio
DB Cargo, dieselelektrische Lokomotive Vossloh DE 18, rot/grau Farbgebung
DB Cargo, locomotive diesel-électrique Vossloh DE 18, livrée rouge/gris
DB Cargo, locomotora diesel-eléctrica Vossloh DE 18, librea roja/gris
DB Cargo, Vossloh DE 18 diesel-electric locomotive, red/grey livery

Das Rivarossi-Modell im Detail

- Neue Variante von Lokgehäuse und Führerhaus
- Neu mit fernsteuerbaren Digitalkupplungen an beiden Enden der Lok (Artikel HR2989S)
- Neuer, fünfpoliger Hochleistungsmotor mit Schwungmassen
- Monitore im Führerpult beleuchtet
- Innenbeleuchtung im Führerhaus
- Chassis aus Zinkdruckguss, Gehäuse auch hochwertigem, fein graviertem Kunststoff
- Alle vier Achsen angetrieben
- Stromabnahme über alle Räder der Lokomotive
- Spitzenbeleuchtung mit der Fahrtrichtung wechselnd
- Kurzkupplungskulissen beidseitig



Photo : Berthold Hertzfeldt

Effishunter 1000



Photo : CZ Loco

HR2972/HR2972S



ČD Cargo, locomotiva diesel Effishunter 1000, livrea blu, nuovo numero di servizio

ČD Cargo, Diesellokomotive des Typs Effishunter 1000, blaue Farbgebung mit neuer Betriebsnummer

ČD Cargo, locomotive diesel Effishunter 1000, livrée bleue, nouvelle immatriculation

ČD Cargo, locomotora diesel Effishunter 1000, decoración azul, nueva matrícula

ČD Cargo, diesel locomotive Effishunter 1000, blue, new running number



Frontale finemente dettagliato con alloggiamenti separati e funzionali alloggiamenti per le luci



Effishunter 1000, livree e numerazioni inedite

- Riproduzione accurata di tutti i dettagli su cofani, cabina, telaio e sottocassa coerentemente differenziati in base all'unità riprodotta
- Affidabile meccanica con telaio e scatole ingranaggi in metallo, potente motore centrale a 5 poli con trasmissione a doppio albero cardanico su entrambi gli assi dei carrelli, due ruote con anello di aderenza
- Impianto elettrico con presa 21 poli NEM 660/21MTC per decoder DCC e DCC Sound, con predisposizione per altoparlante "sugar cube" 11 x 15 mm
- Versioni "S" con decoder sonoro ed altoparlante installati di serie, con suoni specifici per il modello
- Luci bianche di testa e rosse di coda con commutazione automatica in base al senso di marcia e con possibilità di esclusione indipendente tra le due testate
- Terzo faro con comando indipendente dai fanali bassi
- Illuminazione interna in cabina, con interni fedelmente riprodotti, sedili macchinista riportati
- Carrelli estremamente realistici, con numerosi pezzi riportati per sospensione secondaria, smorzatori, cacciapietre, sabbriere, impianto frenante e coperchi boccole con relativi cavi
- Numerosi particolari riportati in metallo o plastica per il massimo realismo.



Carrelli di precisione con dischi freno in metallo



Rivestimento del tubo di scarico realizzati in fotoincisione



Caratteristiche tecniche principali

- Telaio in metallo pressofuso e carrozzeria dettagliata
- Motore a cinque poli ad alte prestazioni con volani
- Illuminazione interna della cabina
- Cruscotto illuminato
- Fanali e luci rosse di coda con commutazione indipendente in modalità digitale
- Interfaccia digitale a 21 poli, portagancio NEM 362

HR2923/HR2923S



Dinazzano Po/TPER, locomotiva diesel da manovra EffiShunter 1000, livrea arancio/grigia

Dinazzano Po/TPER, Diesellokomotive EffiShunter 1000, in orange/grauer Farbgebung

Dinazzano Po/TPER, locomotive de manoeuvre diesel EffiShunter 1000, livrée orange/grise

Dinazzano Po/TPER, locomotora de maniobras diesel EffiShunter 1000, decoración naranja/gris

Dinazzano Po/TPER, diesel shunting locomotive EffiShunter 1000, orange/grey livery



HR2924/HR2924S



FNM/Trenord, locomotiva diesel da manovra EffiShunter 1000, livrea grigia/blu/verde

FNM/Trenord, Diesellokomotive EffiShunter 1000, in grau/blau/grüner Farbgebung

FNM/Trenord, locomotive de manoeuvre diesel EffiShunter 1000, livrée grise/bleue/verte

FNM/Trenord, locomotora de maniobras diesel EffiShunter 1000, decoración gris/azul/verde

FNM/Trenord, diesel locomotive EffiShunter 1000, grey/blue/green livery





Photo : Marco Buono

Rivarossi

E.656

Caratteristiche tecniche principali

- Nuovi stampi per cassa, carrelli e relative parti riportate, con riproduzione accurata di tutte le caratteristiche tipiche delle diverse serie costruttive su frontali, fiancate e tetto
- Affidabile meccanica con telaio articolato e scatole ingranaggi in metallo, potente motore centrale a 5 poli con trasmissione a doppio albero cardanico su entrambi gli assi dei carrelli di estremità, due ruote con anello di aderenza
- Impianto elettrico interamente nuovo, con presa 21 poli NEM 660/21MTC per decoder DCC e DCC Sound, con predisposizione per altoparlante "sugar cube" 11 x 15 mm
- Versioni "S" con decoder sonoro Hornby HM7000 ed altoparlante installati di serie, con suoni specifici per il modello
- Luci bianche di testa e rosse di coda con commutazione automatica in base al senso di marcia e con possibilità di esclusione indipendente tra le due cabine. Posizione dei fanali rossi coerentemente differenziata in base all'unità riprodotta
- Terzo faro con comando indipendente dai fanali bassi
- Illuminazione interna di entrambe le cabine e del corridoio laterale con comando indipendente
- Possibilità di installazione del pattino centrale per funzionamento su sistemi a 3 rotaie, con commutazione del sistema tramite jumper sul circuito stampato
- Portagancio NEM 362 con timone di allontanamento per aggancio corto su entrambe le testate, con possibilità di smontaggio del portagancio per allestire i frontali con tutti i particolari realistici
- Riproduzione accurata dei pantografi Tipo 52 FS interamente in metallo con possibilità di captazione di corrente
- Riproduzione accurata del tetto con numerose parti riportate, griglie dei praticabili in fotoincisione conformi al vero, condizionatori completi di tubazioni dove presenti
- Interni cabina e parete corridoio fedelmente riprodotti, con parti riportate e decorazioni differenziate tra cabine A e B come al vero
- Carrelli Um1250 estremamente realistici, con sospensione secondaria e trave oscillante come pezzi riportati; con o senza riproduzione degli smorzatori antiserpeggio e con 4 o 12 sabbriere, a seconda del periodo di ambientazione; riproduzione dei captatori della Ripetizione Segnali in cabina con boe SCMT dove presenti.



Photo: Carlo Tagliaferri



Photo: Carlo Tagliaferri



Photo: Carlo Tagliaferri

HR2965/HR2965S

HMDCC

IV



FS, locomotiva elettrica E.656, 1ª serie, livrea sperimentale TEE

FS, schwere sechsachsige Elektrolokomotive der Reihe E.656, 1. Serie in experimenteller TEE-Farbgebung

FS, locomotive électrique E.656, 1^{ère} série, livrée expérimentale TEE

FS, locomotora eléctrica E.656, primera serie, decoración "TEE" experimental

FS, six-axle electric locomotive E.656, 1st series in experimental TEE livery



HR2966/HR2966S

HMDCC

IV



FS, locomotiva elettrica E.656, 2ª serie, livrea di origine, con gocciolatoio

FS, schwere sechsachsige Elektrolokomotive der Reihe E.656, 2. Serie in Originalfarbgebung, mit Regenrinne

FS, locomotive électrique E.656, 2^e série, livrée d'origine, avec gouttière

FS, locomotora eléctrica E.656, segunda serie, con vierteaguas, decoración original

FS, six-axle electric locomotive E.656, 2nd series original livery, with gutter



HR2967/HR2967S

H M DCC

V-VI



FS, locomotiva elettrica E.655, 2ª serie, livrea XMPR

FS, schwere sechssachsige Elektrolokomotive der Reihe E.655, 2. Serie in XMPR-Farbgebung

FS, locomotive électrique E.655, 2^{ème} série, livrée XMPR

FS, locomotora eléctrica E.655, segunda serie, decoración "XMPR"

FS, six-axle electric locomotive E.655, 2nd series XMPR livery



HR2968/HR2968S

H M DCC

V



FS, locomotiva elettrica E.656, 4ª serie, livrea di origine, senza gocciolatoio, con smorzatori

FS, schwere sechssachsige Elektrolokomotive der Reihe E.656, 4. Serie in Original Farbgebung, ohne Regenrinne, mit Dämpfern

FS, locomotive électrique E.656, 4^{ème} série, livrée d'origine, sans gouttière et avec ventilateurs

FS, locomotora eléctrica E.656, cuarta serie, sin vierteaguas y con amortiguadores, decoración original

FS, six-axle electric locomotive E.656, 4th series original livery, without gutter, with dampers



HR2979/HR2979HM

HMDCC

IV

NEM 660

210

K

K

K

K

K

K

K

NEW



FS, locomotiva elettrica E.645 2ª serie, livrea castano/Isabella con modanature, carrelli castano, scalette larghe

FS, 6-achs. Elektrolokomotive E.645 2. Serie, Alu-Streifen, braune Drehgestelle, große Trittstufen

FS, locomotive électrique à 6 essieux E.645, 2^{ème} série, bandes en aluminium, bogies marron, grandes marches

FS, locomotora eléctrica de 6 ejes E.645, 2ª serie, franjas de aluminio, bogies marrones, peldaños grandes

FS, 6-axle electric locomotive E.645 2nd series, aluminium stripes, brown bogies, large steps

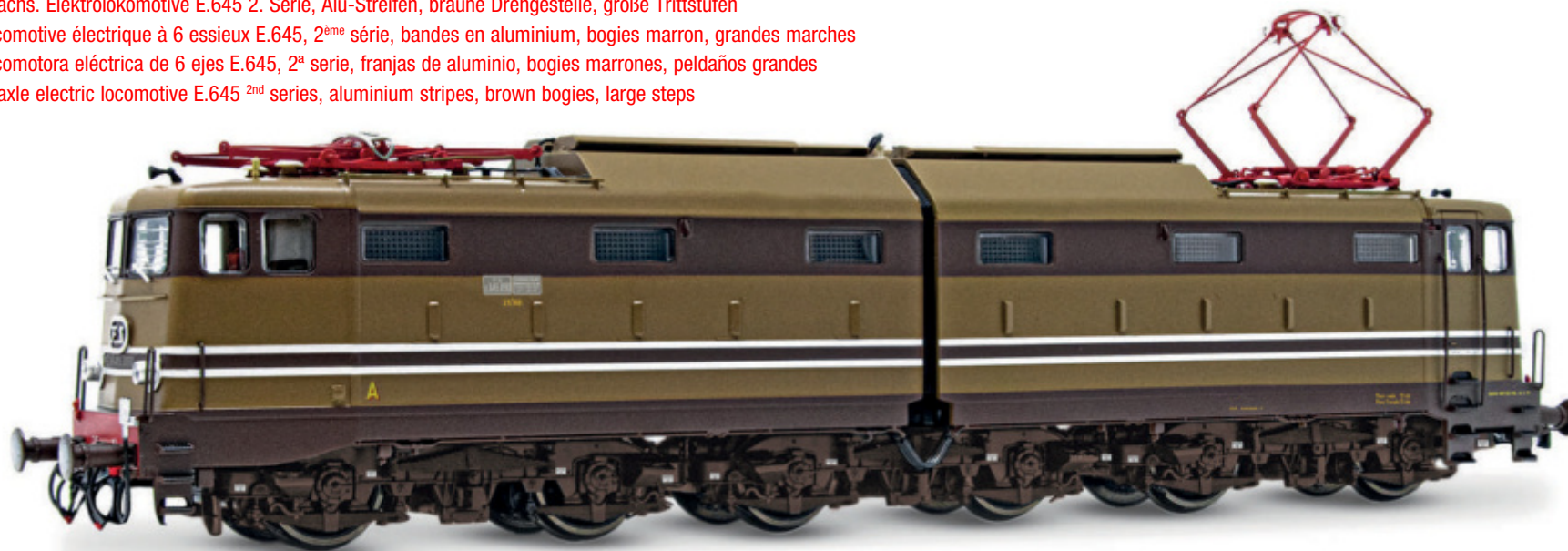

Fotomontaggio / Fotomontage / Photomontage / Fotomontaje

Inedita versione di E645 seconda serie con modanature, scalette larghe, carrelli castano con Ripetizione Segnali, prese d'aria definitive e portelloni lato AT rialzati

Tra la fine degli anni '60 e l'inizio degli anni '70 le E645 ed E646 iniziarono a ricevere le prime modifiche, quali scalette di servizio maggiorate, trombe, tergicristalli e fanali moderni, tientibene sull'imperiale allungati e su entrambi i lati, apparecchiature della Ripetizione Segnali, portelloni di servizio in posizione rialzata per semplificare la manutenzione, prese d'aria riviste in numero e posizione. Spesso queste modifiche erano diluite nel tempo sulle diverse unità del gruppo e ciò ha portato a tantissime combinazioni diverse, ma in alcuni casi potevano essere tutte presenti come nell'unità riprodotta.



HR2979

HR6604-1

HR6604-2

Rivarossi

HR2980/HR2980HM

HMDCC



E 646

NEW



FS, locomotiva elettrica E.646 "Navetta", livrea MDVC con tetto argento, vetri Triplex, con smorzatori

FS, 6-achs. Elektrolokomotive E.646 „Navetta“, MDVC-Lackierung, silbernes Dach, Triplex-Fenster, Seitenklappen

FS, locomotive électrique à 6 essieux E.646 « Navetta », livrée MDVC, toit argenté, fenêtres Triplex, amortisseurs latéraux

FS, locomotora eléctrica de 6 ejes E.646 "Navetta", livrea MDVC, techo plateado, parabrisas Triplex, amortiguadores laterales

FS, 6-axe electric locomotive E.646 "Navetta", MDVC livery, silver roof, Triplex windows, side dampers



Fotomontaggio / Fotomontage / Photomontage / Fotomontaje

Inedita versione di E646 "Navetta" con vetri Triplex e smorzatori antiserpeggio

L'applicazione degli smorzatori antiserpeggio sulle E646 Navetta, con lo scopo di migliorare le qualità di marcia e ridurre l'usura, ebbe inizio nel 1996 ed estesa velocemente a tutto il gruppo, analogamente a quanto già fatto anni prima sulle E656. L'adozione dei vetri frontali corazzati "Triplex" risale invece alla seconda metà anni '80, quindi la combinazione riprodotta in questo modello rappresenta la configurazione più diffusa per queste macchine alla fine del secolo scorso.



HR6621-1

HR6621-2

HR6645-1

HR6645-2

HR2941/HR2941S

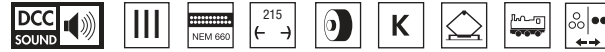

DR, locomotiva elettrica E251 001, livrea verde con carrelli neri

DR, schwere sechssachsige Elektrolokomotive E251 001 in grüner Farbgebung mit schwarzen Drehgestellen

DR, locomotive électrique E251 001, livrée verte avec bogies noirs

DR, locomotora eléctrica E251 001, decoración verde con bogies negros

DR, six-axle electric locomotive E251 001, green livery with black bogies



HR2942/HR2942S

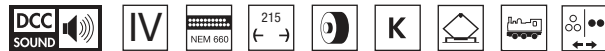

DR, locomotiva elettrica 251 015-4, livrea verde con carrelli rossi

DR, schwere sechssachsige Elektrolokomotive 251 015-4 in grüner Farbgebung mit roten Drehgestellen

DR, locomotive électrique 251 015-4, livrée verte avec bogies rouges

DR, locomotora eléctrica 251 015-4, decoración verde con bogies rojos

DR, six-axle electric locomotive 251 015-4, green livery with red bogies



HR2961/HR2961S

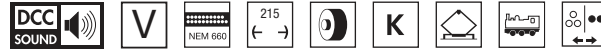

DB AG, locomotiva elettrica, BR 171, livrea rosso traffico

DB AG, schwere sechssachsige Elektrolokomotive der Baureihe 171 in verkehrsroter Farbgebung

DB AG, locomotive électrique, BR 171, livrée rouge trafic

DB AG, locomotora eléctrica BR 171, decoración rojo tráfico

DB AG, heavy six-axle electric locomotive, BR 171, traffic red livery



Technische Daten der neuen Rivarossi-Modelle

- Chassis aus Metalldruckguss
- Kurzkupplungskinematik
- 21-polige Digitalschnittstelle (MTC)
- mittlere Achse im Drehgestell federnd gelagert
- 4 Haftreifen für maximale Zugkraft
- 2 Schwungmassen
- funktionsfähige Stromabnehmer
- Zurüstteile für den Einsatz als Vitrinenmodell
- Dreilicht-Spitzensignal und rotes Schlusslicht mit der Fahrtrichtung wechselnd, Rangierlicht im Digitalbetrieb schaltbar
- Vorbereitet für den Einbau eines Sound-Decoders
- Individuelle Nachbildung der Dachlaufstege (Holz bzw. Metall)
- Individuelle Nachbildung der Signaltürme (verschiedene Bauarten)
- Individuelle Nachbildung der Bremslüfter, je nach Loknummer und Bauzustand
- Individuelle Nachbildung der Sifa, je nach Loknummer und Bauzustand



Photo : Sammlung Hornby

FS ETR 460



Photo : Archivio Rivarossi

Gli **ETR 460** sono i primi rappresentanti della seconda generazione di "Pendolini" delle FS, profonda evoluzione dei primi ETR 450 e caratterizzati dal sistema di pendolamento posizionato sotto al pavimento, che unito alle dimensioni più generose delle casse offrivano molto più spazio utile ai viaggiatori. Costruiti in 10 esemplari da FIAT Savigliano ed entrati in servizio effettivo nel 1995 nella definitiva composizione a 9 elementi di 1a e 2a classe con ristorante, furono subito protagonisti dei servizi più importanti delle FS grazie alla velocità massima di 250 km/h, sebbene per un breve periodo, in quanto poco tempo dopo gli ETR 500 subentrarono sulle relazioni principali mentre gli ETR 460 furono impiegati su altri servizi dove potevano sfruttare meglio le caratteristiche del pendolamento.

Nel dicembre 2011 venne introdotta la categoria di servizio FRECCIABIANCA per collegamenti veloci fuori dalle nuove linee ad alta velocità, che vedeva gli ETR 460 come materiale di punta del servizio, ricevendo la livrea dedicata.

Il nuovo modello Rivarossi

- Riproduzione inedita dell'ETR 460 in configurazione standard
- Nuovo impianto elettrico con presa decoder 21MTC su carrozza motrice e carrozza folle
- Nuovo impianto sonoro con altoparlante "sugar cube" 11x15 mm
- Nuovi pantografi tipo 52AV con smorzatori aggiuntivi
- Inedita livrea Frecciabianca riprodotta in tutti i dettagli

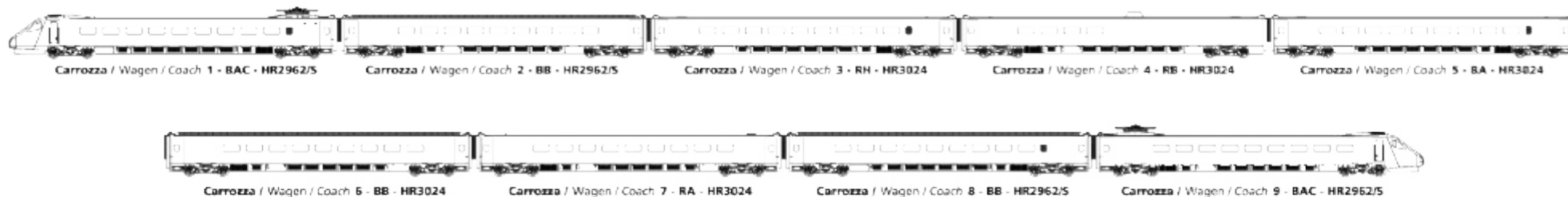

HR2962/HR2962S

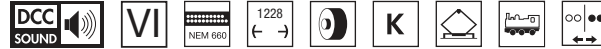

FS, set di 4 unità, treno ad alta velocità ad assetto variabile ETR 460, livrea "Freccia Bianca"

FS, 4-tlg. Grundset Hochgeschwindigkeitszug mit Neigetechnik der Reihe ETR 460 „Freccia Bianca“

FS, coffret de 4 unités de train pendulaire à grande vitesse ETR 460 « Freccia Bianca »

FS, set base de 4 unidades del automotor eléctrico ETR 460 "Freccia Bianca"

FS, 4-unit base set of tilting high-speed train type ETR 460 "Freccia Bianca"

NEW

HR3024

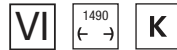

FS, set di 5 carrozze intermedie per il treno ad alta velocità ad assetto variabile ETR 460, livrea "Freccia Bianca"

FS, 5-tlg. Set Zwischenwagen für Hochgeschwindigkeitszug mit Neigetechnik der Reihe ETR 460 „Freccia Bianca“

FS, coffret de 5 voitures intermédiaires du train pendulaire à grande vitesse ETR 460 « Freccia Bianca »

FS, set de 5 coches intermedios para el automotor ETR 460 "Freccia Bianca"

FS, 5-unit pack intermediate coaches of tilting high-speed train type ETR 460 "Freccia Bianca"

NEW



Photo : Superalbs

ETR 470

Das neue Rivarossi-Modell Il nuovo modello Rivarossi

- Nachbildung des ETR 470 in neuer Farbgebung
Riproduzione dell'ETR 470 in livree inedite
- 21-polige Digitalschnittstelle nach NEM 660 in beiden Triebköpfen
Nuovo impianto elettrico con presa decoder 21MTC su carrozza motrice e carrozza folle
- Soundversion mit 11 x 15 mm „Sugarcube“-Lautsprecher
Nuovo impianto sonoro con altoparlante "sugar cube" 11x15 mm
- Funktionsfähige Nachbildung des dritten Scheinwerfers an den Triebköpfen
Riproduzione funzionante del terzo faro sulle carrozze di testa
- Neue Stromabnehmer der Typen 52/92 (Wagen 1/9) und Schunk mit SBB- und DB-Schleifstücken (Wagen 3/7)
Nuovi pantografi tipo 52/92 (carrozze 1/9) e Schunk con striscianti SBB e DB (carrozze 3/7)
- Pfeifen und Hörner an den Endwagen je nach Ausführung unterschiedlich
Fischi e trombe su carrozze di testa differenziati in base alla versione

Composizione del treno - Zugbildung - Train composition - ETR 470

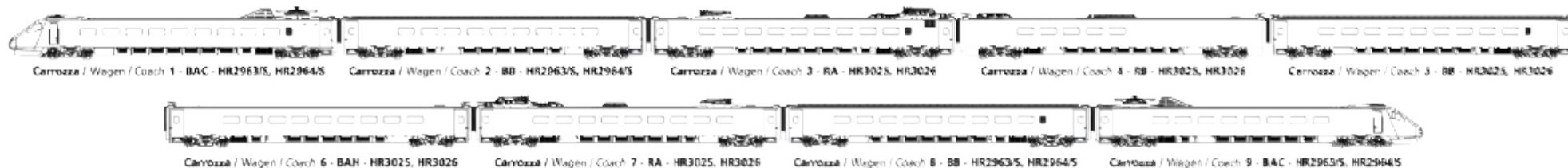





Photo : Enrique Dopico

Die zweite Generation des italienischen „Pendolino“ wurde mit neuen Antrieben und Anordnungen für die elektrische und mechanische Ausrüstung entwickelt, um den Zug nicht nur in Italien, sondern in mehreren europäischen Netzen einsetzen zu können. Der ETR 470 ist das erste Beispiel für einen Mehrsystem-Pendolino: Er wurde in neun Exemplaren zwischen 1996 und 1997 für das italienisch-schweizerische Unternehmen Cisalpino gebaut und war für den Verkehr in Italien, der Schweiz und Deutschland auf Strecken mit 3kV-Gleichstrom oder 15kV-16,7-Hz geeignet. Da die Züge hauptsächlich auf Bergstrecken verkehrten, war die Höchstgeschwindigkeit auf 200 km/h begrenzt. Ab 2008 erhielten die ETR 470 die neue silberne Lackierung mit blauem Streifen, ähnlich wie die neuen ETR 610. Nach der Auflösung der Firma Cisalpino im Dezember 2009 wurden die ETR 470 zwischen Trenitalia (fünf Züge) und den SBB (vier Züge) aufgeteilt und der grenzüberschreitende Verkehr 2015 eingestellt.

La seconda generazione del "Pendolino" FS venne sviluppata con nuovi azionamenti e predisposizioni per apparecchiature elettriche e meccaniche in modo da rendere il treno interoperabile su diverse reti europee, non solo italiane. L'ETR 470 è il primo esempio di Pendolino politensione: costruiti in 9 esemplari tra il 1996 ed il 1997 per la società italo-svizzera Cisalpino, erano atti alla circolazione in Italia, Svizzera e Germania su linee a 3kV CC oppure 15kV 16,7 Hz. Dovendo circolare prevalentemente su linee di montagna, la velocità massima venne limitata a 200 km/h. A partire dal 2008 gli ETR 470 ricevettero la nuova livrea argento con fascia blu, analoga ai nuovi ETR 610, mentre dopo la cessazione della società Cisalpino del dicembre 2009 vennero suddivisi tra Trenitalia (5 treni) e SBB-CFF-FFS (4 treni), terminando i servizi transfrontalieri nel 2015.



HR2963/HR2963S



-  **Cisalpino, set base di 4 unità, treno ad alta velocità ad assetto variabile ETR 470, livrea d'origine con fascia anteriore rossa**
Cisalpino, 4-tlg. Grundset Hochgeschwindigkeitszug mit Neigetechnik der Reihe ETR 470
-  Cisalpino, coffret base de 4 unités, train pendulaire à grande vitesse ETR 470, livrée d'origine avec bande frontale rouge
-  Cisalpino, set base de 4 unidades del automotor eléctrico ETR 470, decoración original con franja roja frontal
- Cisalpino, 4-unit base set of tilting high-speed train type ETR 470 in original livery with red front stripe

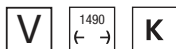

HR3025



-  **Cisalpino, set di 5 carrozze intermedie per il treno ad alta velocità ad assetto variabile ETR 470, livrea originale**
Cisalpino, 5-tlg. Set Zwischenwagen für Hochgeschwindigkeitszug mit Neigetechnik der Reihe ETR 470
-  Cisalpino, coffret de 5 voitures intermédiaires supplémentaires, train pendulaire à grande vitesse ETR 470, livrée d'origine
-  Cisalpino, set de 5 coches intermedios para el automotor ETR 470, decoración original
- Cisalpino, 5-unit pack additional intermediate coaches of tilting high-speed train type ETR 470 in original livery



HR2964/HR2964S

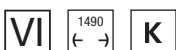

-  **FFS, set base di 4 unità, treno ad alta velocità ad assetto variabile ETR 470, livrea argento con strisce blu**
SBB, 4-tlg. Grundset Hochgeschwindigkeitszug mit Neigetechnik der Reihe ETR 470
-  CFF, coffret base de 4 unités, train pendulaire à grande vitesse ETR 470, livrée argentée avec bande bleue
-  SBB, set base de 4 unidades del automotor eléctrico ETR 470, decoración plata con franja azul
- SBB, 4-unit base set of tilting high-speed train type ETR 470, in silver livery with blue stripe

HR3026



-  **FFS, set di 5 carrozze intermedie per il treno ad alta velocità ad assetto variabile ETR 470, livrea argento con striscia blu**
SBB, 5-tlg. Set Zwischenwagen für Hochgeschwindigkeitszug mit Neigetechnik der Reihe ETR 470
-  CFF, coffret de 5 voitures intermédiaires supplémentaires pour le train pendulaire à grande vitesse ETR 470, livrée argentée avec bande bleue
-  SBB, set de 5 coches intermedios del automotor ETR 470, decoración plata con franja azul
- SBB, 5-unit pack additional intermediate coaches of tilting high-speed train type type ETR 470, in silver livery with blue stripe

NEW

NEW

NEW

NEW



Photo : David Gubler

HR2982/HR2982S

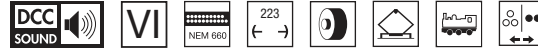

FS, locomotiva elettrica E.402B nuova livrea "Intercity Notte" blu

FS, Elektrolokomotive E.402B in neuer blauer Lackierung „Intercity Notte“

FS, locomotive électrique E.402B dans la nouvelle livrée « Intercity Notte » bleu

FS, locomotora eléctrica E.402B con la nueva livrea azul "Intercity Notte"

FS, electric locomotive E.402B in new "Intercity Notte" new blue livery

NEW



HR4407

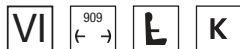

FS, set di 3 carrozze composto da 1 x Gran Confort + 2 x Z1 ricostruite, nuova livrea Intercity

FS, 3-tlg. Set, 1 x Gran Confort-Wagen + 2 x Z1 umgebauten, in neuer Intercity-Farbgebung

FS, coffret de 3 voitures composé de 1 x Gran Confort + 2 x Z1 reconstruites, nouvelle livrée Intercity

FS, set de 3 coches compuesto por 1 x Gran Confort+ 2 x Z1 reconstruidos, en nueva decoración Intercity

FS, 3-unit set of coaches consisting of 1 x Gran Confort + 2 x Z1 rebuilt, new Intercity livery

NEW

Assi sostitutivi per corrente alternata: HC6102 (10.50 x 24.50 mm)



HR4408

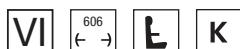

FS, set di 2 carrozze Z1 ricostruite, nuova livrea Intercity Notte

FS, 2-tlg. Set umgebauten Z1-Wagen, in neuer Intercity Notte-Farbgebung

FS, coffret de 2 voitures Z1 reconstruites, nouvelle livrée Intercity Notte

FS, set de 2 coches Z1 reconstruidos, en nueva decoración Intercity Notte

FS, 2-unit set of Z1 coches rebuilt, new Intercity Notte livery

NEW

Assi sostitutivi per corrente alternata: HC6102 (10.50 x 24.50 mm)



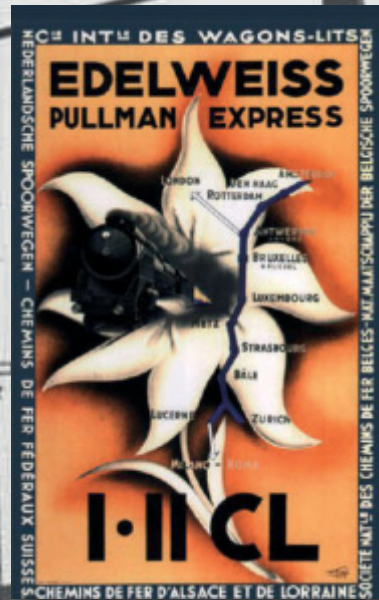

Pullman-Edelweiss-Zug Bahnhof Basel. 1937.

@ Wagons-Lits Diffusion

Der „Edelweiss“ verkehrte von 1928 bis 1979 mit kriegsbedingter Unterbrechung als Zugpaar zwischen der Schweiz und den Niederlanden über das Elsass und Luxemburg. Bis 1939 verkehrte der Zug als von der Internationalen Schlafwagensgesellschaft CIWL betriebener Luxuszug von Amsterdam nach Basel und zweitweise auch Luzern. Nach dem Zweiten Weltkrieg zunächst als normaler Schnellzug geführt,

wurde der Edelweiss ab 1957 eines der ersten Zugpaare des neuen Trans-Europ-Express-Systems (TEE). 1979 wurde er eingestellt. Wenig bekannt ist, dass der Edelweiss Pullman Express der CIWL damals ein direkter Konkurrent des damaligen Rheingolds war. Bis zum Kriegsausbruch verkehrte der Zug südlich von Basel aber auch zusammen mit den Kurswagen des Rheingolds.

Die CIWL setzte im „Edelweiss“ bis 1939 als Fahrzeuge ausschließlich ihre ab 1925 beschafften Pullmanwagen ein. Da diese mit Küche und Am-Platz-Service ausgestattet waren, gab es in der Regel keinen gesonderten Speisewagen und darüber hinaus nur Gepäckwagen. Als Tageszug führte der Edelweiss keine Schlafwagen mit. Im Regelfall bestand der „Edelweiss“ aus mindestens vier Pullmanwagen sowie zwei Gepäckwagen.

HR4390



NEW



CIWL, set di 3 unità "Edelweiss Pullman Express", set 1/2 (DD3, VPC Côte d'Azur + VP Étoile du Nord)

CIWL, 3-tlg. Zugset „Edelweiss Pullman Express“, Set 1/2 (DD3, VPC Côte d'Azur + VP Étoile du Nord)

CIWL, coffret de 3 unités « Edelweiss Pullman Express », set 1/2 (DD3, VPC Côte d'Azur + VP Étoile du Nord)

CIWL, primer set de 3 coches "Edelweiss Pullman Express", compuesto de un coche DD3, un VPC "Côte d'Azur" y un VP "Étoile du Nord"

CIWL, 3-unit pack "Edelweiss Pullman Express", train set 1/2 (DD3, VPC Côte d'Azur + VP Étoile du Nord)

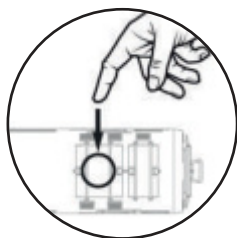

Vetture dotate di illuminazione interna con touch control per attivare e variare l'intensità



Fotomontaggio / Fotomontage / Photomontage / Fotomontaje

HR4391



NEW



CIWL, set di 3 unità "Edelweiss Pullman Express", set 2/2 (DD3, VPC Flèche d'Or + VP Étoile du Nord)

CIWL, 3-tlg. Zugset „Edelweiss Pullman Express“, Set 2/2 (DD3, VPC Flèche d'Or + VP Étoile du Nord)

CIWL, coffret de 3 unités « Edelweiss Pullman Express », set 2/2 (DD3, VPC Flèche d'Or + VP Étoile du Nord)

CIWL, segundo set de 3 coches "Edelweiss Pullman Express", compuesto de un coche DD3, un VPC "Flèche d'Or" y un VP "Étoile du Nord"

CIWL, 3-unit pack "Edelweiss Pullman Express", train set 2/2 (DD3, VPC Flèche d'Or + VP Étoile du Nord)

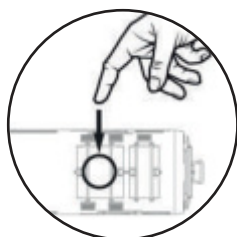

Vetture dotate di illuminazione interna con touch control per attivare e variare l'intensità



Fotomontaggio / Fotomontage / Photomontage / Fotomontaje

HR4389

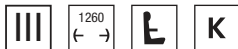

DB, set di 5 carrozze passeggeri "Blauer Enzian", livrea blu
DB, 5-tlg. Zugset „Blauer Enzian“ in blauer Farbgebung
DB, coffret de 5 voitures « Blauer Enzian », livrée bleue
DB, set de 5 coches "Blauer Enzian", decoración azul
DB, 5-unit pack luxury passanger train "Blauer Enzian", blue livery

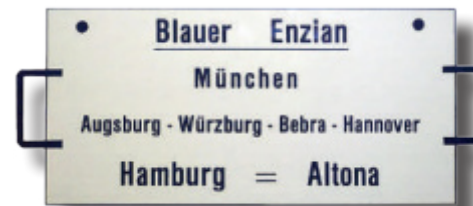

Der Blauer Enzian

Ab Sommerfahrplan 1953 wurde der Zug durch die eingesetzten Wagen aus den Fernschnellzügen herausgehoben.

Die Garnitur des früheren Henschel-Wegmann-Zuges, die einen Aussichtsschlusswagen nach US-Vorbild führte (Kanzelwagen), wurde speziell für diesen Einsatz aufgearbeitet. Wegen Problemen beim Umbau der Zuggarnitur, die ursprünglich aus Wagen mit Abteilen zweiter und dritter Klasse bestand, entschied die DB, den Zug generell auf die (damalige) zweite Wagenklasse umzurüsten.

Der Name „Blauer Enzian“, den die Verbindung seit Sommerfahrplan 1952 trug, war das Ergebnis eines Preisausschreibens, das die DB unter ihren Fahrgästen 1951 veranstaltete. Insgesamt wurden so für neun F-Zug-Paare Namen vergeben.

Für den F 55/56 kristallisierte sich der Name „Blauer Enzian“ als Gewinner heraus. Enzian ist wie das Edelweiß – namensgebend für den Edelweiss-Express – eine Alpenblume und Heilpflanze. In Europa wachsen etwa 35 Enzian-Arten vorwiegend in den Alpen. Möglicherweise wegen ihrer im Pflanzenreich seltenen reinblauen und leuchtenden Blütenfarbe, wurden und werden sie als Symbol für die Treue betrachtet und werden so in Gedichten und Liedern erwähnt. Streckenführung und Farbgebung des Zugs können die Assoziation erklären.

Fotomontaggio / Fotomontage / Photomontage / Fotomontaje

Photo: Collezione Rivarossi



HR4397

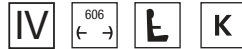

DB, set di 2 carrozze di 1a classe del tipo Avmz¹¹¹ in colorazione Rheingold-'83, (per completare i set HR4346 e HR4347)

DB, 2-tlg. Set 1.-Kl.-Wagen der Bauart Avmz¹¹¹ in Rheingold-'83-Farbgebung, (zur Komplettierung der Sets HR4346 und HR4347)

DB, coffret de 2 voitures de 1^{ère} classe du type Avmz¹¹¹ en livrée Rheingold '83, (pour compléter les coffrets HR4346 et HR4347)

DB, set de dos coches tipo Avmz¹¹¹, decoración "Rheingold 1983", (para completar los sets HR4346 y HR4347)

DB, 2-unit pack Avmz¹¹¹ 1st cl. coaches in Rheingold 1983 livery, (they complete the packs HR4346 and HR4347)

Passende AC-Tauschradsätze: HC6102 (10.50 x 24.50 mm)

Gastronomisch entgleist, aber mit Whirlpool!

Als besondere Attraktion wurde auf einen Teil der Strecke anstelle eines Speisewagens der Rheingold-Clubwagen eingesetzt. In diesem umgebauten Großraumwagen mit 34 Drehsesseln an fünfzehn Tischen wurden den Fahrgästen landestypische „Clubschmankerl“ serviert. Daneben stellten sich an der Strecke gelegene Orte oder Reisegebiete vor, boten touristische Attraktionen sowie folkloristische Einlagen und versuchten auf diese Weise, Gäste anzuziehen. Für kurze Zeit war im Clubwagen, der sich mehr und mehr zum Partywagen entwickelte, sogar ein Whirlpool „für das Schaumbad bei Tempo 160“ installiert.

Mit dem neuen Rivarossi-Modell können Sie sich nun das typische Flair der achtziger Jahre auf ihre Modellbahn holen. Set HR4397 an, mit dem der zehnteilige „Rheingold '83“ vorbildgerecht vervollständigt werden kann.



Fotomontaggio / Fotomontage / Photomontage / Fotomontaje



HR4395

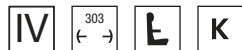

DB, carrozza bar WGmh⁸⁰⁴ per treni storici in livrea originale

DB, Barwagen WGmh⁸⁰⁴ in Ursprungsfarbgebung für historische Züge

DB, voiture-bar WGmh⁸⁰⁴ pour trains historiques en livrée d'origine

DB, coche bar tipo WGmh⁸⁰⁴, para trenes históricos

DB, bar coach WGmh⁸⁰⁴ for historic trains in original livery

Passende AC-Tauschradsätze: HC6102 (10.50 x 24.50 mm)



Fotomontaggio / Fotomontage / Photomontage / Fotomontaje

HR4409



FS, carrozza UIC-X 1979 per il trasporto detenuti, livrea rosso/grigio

FS, UIC-X 1979 Gefangenentransportwagen, rot/grau Farbgebung

FS, voiture UIC-X 1979 pour le transport des prisonniers, livrée rouge/grise

FS, coche UIC-X 1979 para transporte de prisioneros, decoración rojo/gris

FS, UIC-X 1979 coach for the transport of prisoners, red/grey livery

NEW

Assi sostitutivi per corrente alternata: HC6102 (10.50 x 24.50 mm)



Fotomontaggio / Fotomontage / Photomontage / Fotomontaje

Le carrozze "cellulare" delle FS



Sin dagli inizi del '900, le Ferrovie dello Stato offrono il servizio di trasferimento di detenuti, utilizzando carrozze specificamente attrezzate per motivi di sicurezza, cosiddette "cellulari". Erano di norma dotate di un numero variabile di celle chiuse (in base alla tipologia di carrozza), spazi dedicati alle guardie di accompagnamento, grate a porte e finestrini, senza intercomunicanti di testa.

La salita/discesa dei detenuti doveva essere effettuata sempre in stazioni isolate o poco affollate, con tutte le accortezze del caso e dal lato opposto rispetto alla normale affluenza dei passeggeri per evitare il più possibile il contatto visivo e fisico. Nel caso in cui non si potesse effettuare un treno dedicato con solo la carrozza cellulare, questa veniva inserita in composizione a treni passeggeri ordinari, di norma immediatamente dietro alla macchina titolare del treno, ovviamente isolata dai passeggeri regolari.

Negli anni '70 le FS progettarono un nuovo tipo di carrozza "cellulare", basato sulle UIC-X accorciate in lunghezza e con diversa organizzazione interna, ma in seguito il progetto venne annullato e nel 1986 al posto di questo vennero trasformate due carrozze UIC-X Tipo 1979 di seconda classe, precedentemente danneggiate per incidenti, che subirono la soppressione delle porte di testa, applicazione di grate a porte di salita e degli scompartimenti interni attrezzati a celle, ed apertura dei finestrini limitata a 10 cm. Restarono in servizio fino al 2001, quando vennero ritrasformate in carrozze passeggeri ordinarie.

HR4416



-  **DB Nachtzug, set di 2 carrozze cuccette Bvcmz²⁴⁸, livrea bianco/rosso**
-  **DB Nachtzug, 2-tlg. Set Liegewagen Bvcmz²⁴⁸, in weiß/roter Farbgebung**
- DB Nachtzug, coffret de 2 voitures-couchettes Bvcmz²⁴⁸, livrée blanche/rouge**
- DB Nachtzug, set de 2 coches literas Bvcmz²⁴⁸, decoración blanco/rojo**
- DB Nachtzug, 2-unit set of couchettes Bvcmz²⁴⁸, white/red livery**



NEW

Passende AC-Tauschradsätze: HC6102 (10.50 x 24.50 mm)



HR4417



-  **Euro-Express, set di 3 carrozze cuccette, composto da 1 x Bcm²⁴³ + 1 x Bcm²⁴⁶ + 1 x Bvcmz, livrea viola**
-  **Euro-Express, 3-tlg. Set Liegewagen, bestehend aus 1 x Bcm²⁴³, 1 x Bcm²⁴⁶ und 1 x Bvcmz, in violetter Farbgebung**
- Euro-Express, coffret de 3 voitures-couchettes, composé de 1 x Bcm²⁴³ + 1 x Bcm²⁴⁶ + 1 x Bvcmz, livrée violette**
- Euro-Express, set de 3 coches literas, compuesto por 1 x Bcm²⁴³, 1 x Bcm²⁴⁶ y 1 x Bvcmz, en decoración violeta**
- Euro-Express, 3-unit set of couchette coaches, consisting of 1 x Bcm²⁴³ + 1 x Bcm²⁴⁶ + 1 x Bvcmz, in purple livery**

NEW

Passende AC-Tauschradsätze: HC6102 (10.50 x 24.50 mm)

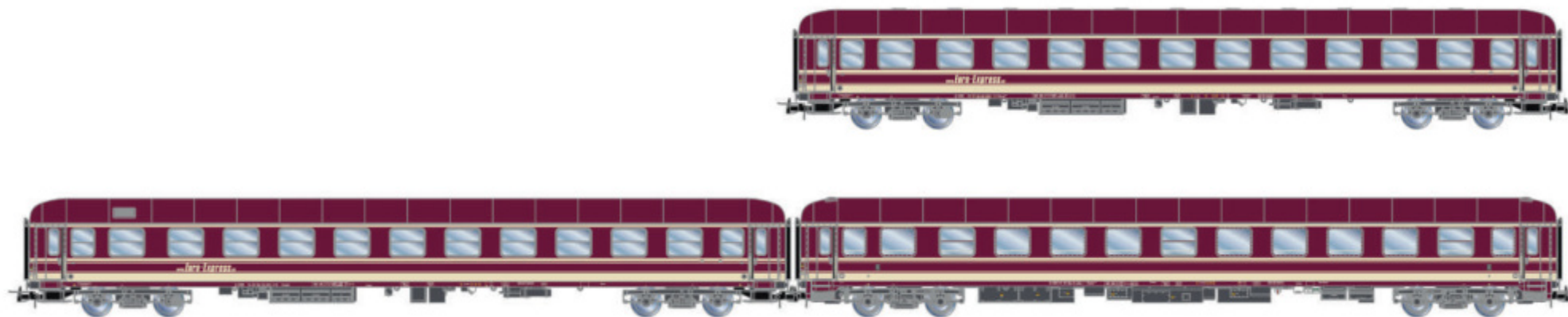

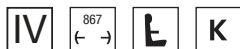
HR4418**NEW**

DR, set di 3 carrozze treno auto-cuccette "Berlino – Lörrach", composto da 1 x Bc + 1 x WLAB + 1 x DDm, livrea verde/rossa

DR, 3-tlg. Set des Autoreisezug „Berlin – Lörrach“, bestehend aus 1 x Bc, 1 x WLAB und 1 x DDm, in grün-roter Farbgebung

DR, coffret de 3 voitures train-auto-couchettes « Berlin – Lörrach », composé de 1 x Bc + 1 x WLAB + 1 x DDm, livrée verte/rouge

DR, set de 3 coches tren-auto literas "Berlín – Lörrach", compuesto por 1 x Bc, 1 x WLAB y 1 x DDm, en decoración verde y roja

DR, 3-unit set of car sleeper train "Berlin – Lörrach", consisting of 1 x Bc + 1 x WLAB + 1 x DDm, green/red livery

Passende AC-Tauschradsätze: HC6104 (11.50 x 24.00 mm)

Autoreisezug Berlin – Lörrach

Bereits in den siebziger Jahren verkehrten Autoreisezüge von Berlin nach Lörrach. Diese Züge waren vor der Ölkrise von 1973 oft nur drei Wagen lang, genau wie unser Set HR4418. Diese Züge wurden in Westdeutschland von DB-Lokomotiven der BR 141 gezogen und verkehrten nur an ausgewählten Tagen.

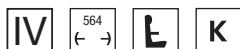
**HR4419****NEW**

DR, set di 2 carrozze letto tipo OSShD WLAB, livrea rossa senza linee decorative

DR, 2-tlg. Set OSShD-Schlafwagen WLAB, in roter Farbgebung ohne Zierlinien

DR, coffret de 2 voitures-lits OSShD type WLAB, livrée rouge sans lignes décoratives

DR, set de 2 coches literas tipo OSShD WLAB, en decoración roja sin líneas decorativas

DR, 2-unit set of OSShD type sleeping coaches WLAB, red livery without decorative lines

Passende AC-Tauschradsätze: HC6104 (11.50 x 24.00 mm)



HR4349

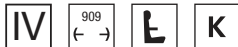

DB, set di 3 carrozze, treno notturno "Luna", composto da 1 carrozza Club WGmh 854 in livrea rosso/beige e 2 carrozze Bcm 246 in livrea blu oceano/begie
DB, 3-tlg. Set Nachtschnellzug „Luna“, bestehend aus 1 x Bar-Gesellschaftswagen WGmh 854, in rot/beiger Farbgebung und 2 x Bcm 246, in ozeanblauer Farbgebung
DB, coffret de 3 voitures, train de nuit « Luna », composé de 1 voiture Club WGmh 854 en livrée rouge/beige et 2 voitures Bcm 246 en livrée bleu océan
DB, set de 3 coches, tren nocturno "Luna", compuesto de 1 coche Club WGmh 854 en decoración rojo/beige y 2 coches bcm 246 en decoración océano azul
DB, 3-unit pack, night train "Luna", including 1 Club coach WGmh 854 in red/beige livery and 2 coaches Bcm 246 in ocean blue livery

NEW

Passende AC-Tauschradsätze: HC6102 (10.50 x 24.50 mm)



HR4377

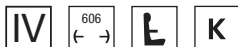

DB, set di 2 carrozze cuccette Bcm²⁴³, livrea verde
DB, 2-tlg. Set Liegewagen Bcm²⁴³, in grüner Farbgebung
DB, coffret de 2 voitures couchettes Bcm²⁴³, livrée verte
DB, set de dos coches literas Bcm²⁴³, decoración verde
DB, 2-unit pack of couchette coaches Bcm²⁴³, green livery

NEW

Passende AC-Tauschradsätze: HC6102 (10.50 x 24.50 mm)



HR4348

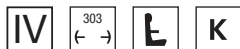

DB, carrozza Club WGmh⁸⁵⁴, livrea "InterRegio"

DB, Bar-Gesellschaftswagen WGmh⁸⁵⁴, in „InterRegio“-Farbgebung

DB, voiture Club WGmh⁸⁵⁴, livrée « InterRegio »

DB, coche Club WGmh⁸⁵⁴, decoración «InterRegio»

DB, Club coach WGmh⁸⁵⁴, "InterRegio" Livery

NEW

Passende AC-Tauschradsätze: HC6102 (10.50 x 24.50 mm)



HR4350

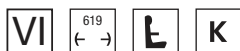

Euro-Express, set di 2 carrozze, composto da 1 carrozza "Partywagen" WGmh 804/854 e 1 carrozza ristorante WRmh 132

Euro-Express, 2-tlg. Set Reisezugwagen, bestehend aus 1 x Partywagen WGmh 804/854 und 1 x Speisewagen WRmh 132

Euro-Express, coffret de 2 voitures, composé de 1 voiture « Partywagen » WGmh 804/854 et 1 voiture restaurant WRmh 132

Euro-Express, set de 2 coches, compuesto de 1 coche "Partywagen" WGmh 804/854 y 1 coche restaurante WRmh 132

Euro-Express, 2-unit set of coaches, including 1 "Partywagen" coach WGmh 804/854 and 1 restaurant coach WRmh 132

NEW

Passende AC-Tauschradsätze: HC6102 (10.50 x 24.50 mm)



HR4373

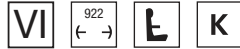

NEW



DB, set di 3 carrozze "TEE Bavaria", livrea rossa/beige, composto da 1 carrozza Apmz, 1 carrozza Avmz e 1 carrozza ARDm

DB, 3-tlg. Set Reisezugwagen „TEE Bavaria“ in rot/beiger Farbgebung, bestehend aus 1 x Apmz, 1 x Avmz, 1 x ARDm

DB, coffret de 3 voitures « TEE Bavaria », livrée rouge/beige, composé de 1 voiture Apmz, 1 voiture Avmz et 1 voiture ARDm

DB, set de 3 coches «TEE Bavaria», decoración roja/beige, compuesto de 1 coche Apmz, 1 coche Avmz y 1 coche ARDm

DB,3-unit set of coaches "TEE Bavaria", red/beige livery, including 1 coach Apmz, 1 coach Avmz and 1 coach ARDm

Passende AC-Tauschradsätze: HC6102 (10.50 x 24.50 mm)



TEE Bavaria

Ein sehr bekannter, internationaler Fernzug, war der „Bavaria“. Von 1969 bis 1977 war er Bestandteil des Trans-Europäischen Eisenbahn-Netzes, kurz TEE genannt. Er verkehrte in der Relation München – Zürich und befuhr dabei die landschaftlich schöne Allgäubahn bis Lindau. Die zunächst eingesetzten 4-teiligen Dieseltriebzüge des Typs RAm wurden nach einem schweren Unfall 1971 dort nicht mehr eingesetzt.

Als Nachfolge wurden die deutschen TEE-Wagen des Typs Avmz 111 (Abteilwagen) und Apmz 121 (Großraumwagen) sowie als Besonderheit der extra in TEE-Farben lackierte SBB-Speisewagen WRm eingesetzt. Mit den goldbedampften Einstiegstüren, den Aufschriften „TEE“ mit Ring-Umrandung sowie „Restaurant“ war dieser schon von weitem von allen anderen TEE-Wagen leicht zu unterscheiden. Der Zug verkehrte drei- bzw. vierteilig, je nach Auslastung.

Als Zuglokomotiven kam die neue Baureihe 210 zwischen München und Lindau zum Einsatz, ersatzweise auch die Baureihe 218, zunächst im ursprünglichen purpurrot, ab Mitte der 1970-er Jahre auch in den neuen Farben ozeanblau/beige. Ab 1977 wurde der TEE 66/67 „Bavaria“ zum D-Zug herabgestuft und Ende 2002 verlor die Zugverbindung München – Zürich endgültig den Namen „Bavaria“.

HR4381

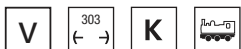

DB AG, carro DDm⁹¹⁶ per trasporto auto al seguito, livrea verde

DB AG, Autotransportwagen DDm⁹¹⁶, in grüner Farbgebung

DB AG, fourgon porte-autos DDm⁹¹⁶, livrée verte

DB AG, vagón plataforma portacoaches DDm⁹¹⁶, decoración verde

DB AG, car transporter DDm⁹¹⁶, green livery

NEW



Das neue Rivarossi-Modell im Detail

- Vollständige Neukonstruktion
- Modell mit Chassis aus Zinkdruckguss für einigen tiefliegenden Schwerpunkt
- Unterschiedliche Detaillierung je nach Ausführung

- Viele separate angesetzte Details, teilweise aus rostfreiem Edelstahl geätzt
- Kurzkupplungskulissen nach NEM 352
- Kupplungsaufnahmen nach NEM 362
- Fein profilierte und dunkel vernickelte Radsätze
- Chassis aus Zinkspritzguss für optimale Laufeigenschaften

HR4421

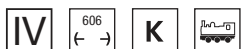

DR, set di 2 carri trasporto auto DD⁹¹⁶, livrea blu

DR, 2-tlg. Set Autotransportwagen DDm⁹¹⁶, in blauer Farbgebung

DR, coffret de 2 wagons porte-autos DDm⁹¹⁶, livrée bleue

DR, set de 2 vagones portacoaches DDm⁹¹⁶, en decoración azul

DR, 2-unit set of DDm⁹¹⁶ car transporters, blue livery

NEW

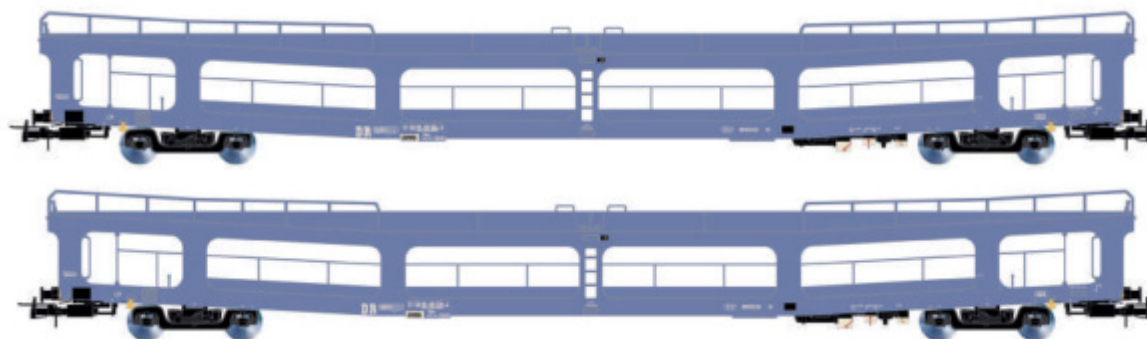

HR4420

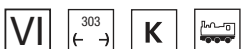

ŽSSK, carro trasporto auto DDm⁹¹⁶, livrea blu-arancio

ŽSSK, Autotransportwagen DDm⁹¹⁶, in blau-orangefarbener Farbgebung

ŽSSK, wagon porte-autos DDm⁹¹⁶, livrée bleu-orange

ŽSSK, vagón portacoaches DDm⁹¹⁶, en decoración azul-naranja

ŽSSK, DDm⁹¹⁶ car transporter, blue-orange livery

NEW



HR6643

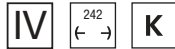

DB, set di 2 carri trasporto gas a 2 assi Zgs, "Linde"

DB, 2-tlg. Set 2-achs. Gaskesselwagen der Bauart Zgs, „Linde“

DB, coffret de 2 wagons gaziers à 2 essieux Zgs, « Linde »

DB, set de 2 vagones cisterna de gas de 2 ejes tipo Zgs, decoración "Linde"

DB, 2-unit set of 2-axle gas tank wagons Zgs, "Linde"

NEW

Passende AC-Tauschradsätze: HC6104 (11.27 x 24.25 mm)



HR6644

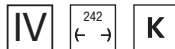

DB, set di 2 carri trasporto gas a 2 assi Zgs, "Rommenhöller Kohlensäure"

DB, 2-tlg. Set 2-achs. Gaskesselwagen, „Rommenhöller Kohlensäure“

DB, coffret de 2 wagons gaziers à 2 essieux Zgs, « Rommenhöller Kohlensäure »

DB, set de 2 vagones cisterna de gas de 2 ejes, decoración "Rommenhöller Kohlensäure"

DB, 2-unit set of 2-axle gas tank wagons, "Rommenhöller Kohlensäure"

NEW

Passende AC-Tauschradsätze: HC6104 (11.27 x 24.25 mm)



HR6666

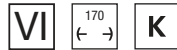

WASCOSA, carro cisterna a 4 assi, livrea blu

WASCOSA, 4-achs. Kesselwagen, blaue Farbgebung

WASCOSA, wagon-citerne à 4 essieux, livrée bleue

WASCOSA, vagón cisterna de 4 ejes, decoración azul

WASCOSA, 4-axle tank wagon, blue livery

NEW

Passende AC-Tauschradsätze: HC6100 (10.27 x 25,20 mm)



Fotomontaggio / Fotomontage / Photomontage / Fotomontaje

HR6667

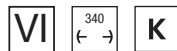

GATX, set di 2 carri cisterna a 4 assi, livrea grigio chiaro con grande logo GATX

GATX, 2-tlg. Set isolierter 4-achs. Kesselwagen, silberne Farbgebung mit großem GATX-Logo

GATX, coffret de 2 wagons-citernes à 4 essieux, livrée gris clair avec grand logo GATX

GATX, set de 2 wagones cisterna aislados de 4 ejes, decoración gris claro con gran logotipo de GATX

GATX, 2-unit set of 4-axle tank wagons, light grey livery with big GATX logo

NEW

Passende AC-Tauschradsätze: HC6100 (10.27 x 25,20 mm)



Fotomontaggio / Fotomontage / Photomontage / Fotomontaje

HR6670

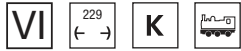

DB AG, carro pianale con stanti a 4 assi tipo Res, livrea grigio scuro, senza carico

DB AG, 4-achs. Rungenwagen, Typ Res, dunkelgraue Farbgebung (leer)

DB AG, wagon à poutres de 4 essieux type Res, livrée gris foncé, sans chargement

DB AG, vagón teleros de 4 ejes tipo Res, decoración gris oscuro (vacío)

DB AG, 4-axle stake wagon, Res type, dark grey livery, without load

NEW

Passende AC-Tauschradsätze: HC6100 (10.27 x 25,20 mm)

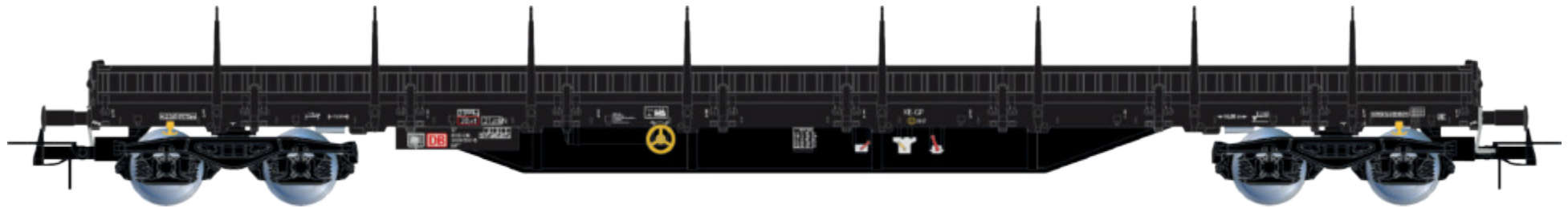

HR6671



Press, set di 2 carri pianale con stanti a 4 assi tipo Res, livrea blu, senza carico

Press, 2-tlg. Set 4-achs. Rungenwagen, Typ Res, blaue Farbgebung (leer)

Press, coffret de 2 wagons à poutres de 4 essieux type Res, livrée bleue, sans chargement

Press, set de 2 wagones teleros de 4 ejes tipo Res, decoración azul (vacíos)

Press, 2-unit set of 4-axle stake wagons, Res type, blue livery, without load

NEW

Passende AC-Tauschradsätze: HC6100 (10.27 x 25,20 mm)



HR6672

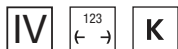

SNCF, carro cisterna per trasporto benzina a 3 assi "WIDENMEYER", livrea grigia
SNCF, 3-achs. Kesselwagen der saarländ. Heizölgesellschaft „WIDENMEYER“, grau
SNCF, wagon-citerne à 3 essieux pour le transport de fioul « WIDENMEYER », livrée grise
SNCF, vagón cisterna de gasolina de 3 ejes de la compañía de gasóleo de calefacción del Sarre "WIDENMEYER"
SNCF, 3-axle tank wagon for the transport of heating-oil "WIDENMEYER", grey livery

Die dreiachsigen Kesselwagen bildeten für lange Zeit das Rückgrat des Rohölverkehrs bei der SNCF. Einige Wagen wurden auch an deutsche Firmen wie die Firma Widenmeyer aus dem Saarland vermietet und in Deutschland eingesetzt.

NEW

Passende AC-Tauschratsätze: HC6101 (11.27 x 24.25 mm)



Fotomontaggio / Fotomontage / Photomontage / Fotomontaje

HR6673

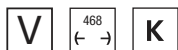

FS, set di 2 carri chiusi tipo Habils, in livrea argento/marrone con logo FS inclinato e a televisore
FS, 2-tlg. Set Schiebewandwagen der Bauart Habils, in silber/brauner Farbgebung mit geneigtem und abgerundetem FS-Logo
FS, coffret de 2 wagons fermés Habils, en livrée argent/marron avec logo FS incliné et arrondi
FS, set de 2 vagones cerrados Habils, en decoración plateada/marrón con logotipo FS inclinado y redondeado
FS, 2-unit set of Habils closed wagons, in silver/brown livery with inclined and rounded FS logo

NEW

Assi sostitutivi per corrente alternata: HC6100 (10.27 x 25.20 mm)



Fotomontaggio / Fotomontage / Photomontage / Fotomontaje



HR2967

HR6673-1

HR6673-2

HR6598-1

H6598-2

HR6649

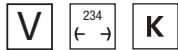

NEW



SBB, carro a pareti scorrevoli a 4 assi tipo Habils "Danzas"

SBB, 4-achs. Schiebewandwagen der Bauart Habils „Danzas“

SBB, wagon à parois coulissantes à 4 essieux type Habils « Danzas »

SBB, vagón de 4 ejes de paredes deslizantes tipo Habils, decoración "Danzas"

SBB, 4-axle sliding-wall wagon type Habils "Danzas"

Passende AC-Tauschradsätze: HC6100 (10.27 x 25.20 mm)



Fotomontaggio / Fotomontage / Photomontage / Fotomontaje

HR6650

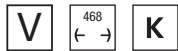

NEW



SBB, set di 2 carri a pareti scorrevoli a 4 assi tipo Habils, livrea con pezzature

SBB, 2-tlg. Set 4-achs. Schiebewandwagen der Bauart Habils in Flickenfarbgebung

SBB, coffret de 2 wagons à parois coulissantes à 4 essieux type Habils, livrée avec retouches

SBB, vagón de 4 ejes de paredes deslizantes tipo Habils, con parches

SBB, 2-unit set of 4-axle sliding-wall wagon type Habils, livery with patches

Passende AC-Tauschradsätze: HC6100 (10.27 x 25.20 mm)



Fotomontaggio / Fotomontage /
Photomontage / Fotomontaje



HR6651

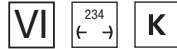

- CH-AHD, carro a pareti scorrevoli a 4 assi tipo Habils-vy, "MATTONI", numerazione 31 85 275 0 502-4**
CH-AHD, 4-achs. Schiebewandwagen der Bauart Habils-vy, „MATTONI“, Betriebsnummer 31 85 275 0 502-4
CH-AHD, wagon à parois coulissantes à 4 essieux type Habils-vy, « MATTONI », immatriculation 31 85 275 0 502-4
CH-AHD, vagón de 4 ejes de paredes deslizantes tipo Habils-vy, decoración "MATTONI", matrícula 31 85 275 0 502-4
CH-AHD, 4-axle sliding-walls wagon type Habils-vy, "MATTONI", running number 31 85 275 0 502-4

NEW

Passende AC-Tauschradsätze: HC6100 (10.27 x 25.20 mm)



Fotomontaggio / Fotomontage / Photomontage / Fotomontaje

HR6565

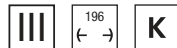

- FS, set di 2 carri cisterna a 2 assi "Total"**
FS, 2-tlg. Set 2-achs. Kesselwagen „Total“
FS, coffret de 2 wagons-citernes à 2 essieux « Total »
FS, set de 2 wagones cisterna de 2 ejes, decoración "Total"
FS, 2-unit set of 2-axle tank wagons "Total"

NEW

Assi sostitutivi per corrente alternata: HC6101 (11.27 x 24.25 mm)



HR6566

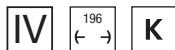

FS, set di 2 carri cisterna a 2 assi "api"

FS, 2-tlg. Set 2-achs. Kesselwagen „API“

FS, coffret de 2 wagons-citernes à 2 essieux « api »

FS, set de 2 wagones cisterna de 2 ejes, decoración "Api"

FS, 2-unit set of 2-axle tank wagons "api"

NEW

Assi sostitutivi per corrente alternata: HC6101 (11.27 x 24.25 mm)



HR6567

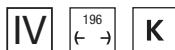

FS, set di 2 carri cisterna a 2 assi "BP"

FS, 2-tlg. Set 2-achs. Kesselwagen „BP“

FS, coffret de 2 wagons-citernes à 2 essieux « BP »

FS, set de 2 wagones cisterna de 2 ejes, decoración "BP"

FS, 2-unit set of 2-axle tank wagons "BP"

NEW

Assi sostitutivi per corrente alternata: HC6101 (11.27 x 24.25 mm)



HR6674

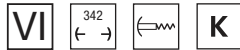

GATX, set di 2 carri silo a pareti curve a 4 assi "RAIL CARGO GROUP", livrea verde neon

GATX, 2-tlg. Set 4-achs. Getreidesilowagen „RAIL CARGO GROUP“, neongrüne Farbgebung

GATX, coffret de 2 wagons silos à parois bombées à 4 essieux « RAIL CARGO GROUP », livrée vert néon

GATX, set de 2 wagones tolva redondeados de 4 ejes "RAIL CARGO GROUP", decoración verde neón

GATX, 2-unit set of 4-axle round-sided silo wagons "RAIL CARGO GROUP", neon-green livery

NEW

Passende AC-Tauschradsätze: HC6100 (10.27 x 25.20 mm)



HR6675

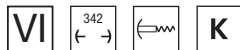

ATIR-RAIL, set di 2 carri silo a pareti curve a 4 assi, livrea grigia

ATIR-RAIL, 2-tlg. Set 4-achs. Getreidesilowagen, graue Farbgebung

ATIR-RAIL, coffret de 2 wagons silos à parois bombées à 4 essieux, livrée grise

ATIR-RAIL, set de 2 wagones tolva redondeados de 4 ejes, decoración gris

ATIR-RAIL, 2-unit set of 4-axle round-sided silo wagons, grey livery

NEW

Passende AC-Tauschradsätze: HC6100 (10.27 x 25.20 mm)

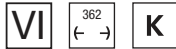

HR6546

NACCO, set di 2 carri tramoggia a 4 assi Taoos, livrea gialla, "Josera"
 NACCO, 2-tlg. Set 4-achs. Schwenkdachwagen Taoos, in gelber Farbgebung, „Josera“
 NACCO, coffret de 2 wagons trémie à 4 essieux Taoos, livrée jaune, « Josera »
 NACCO, set de dos vagones tolva tipo Taoos, decoración amarilla "Josera"
 NACCO, 2-unit set of 4-axle hopper wagons Taoos, yellow livery, "Josera"

NEW

Passende AC-Tauschradsätze: HC6100 (10.27 x 25.20 mm)



Fotomontaggio / Fotomontage / Photomontage / Fotomontaje

Das Rivarossi-Modell im Detail

- Vollständige Neukonstruktion
- Unterschiedliche Details je nach Bauserie (versch. Chassis mit unterschiedl. Länge, unterschiedl. Bremsgestänge etc.)
- Kurzkupplungskulissen beidseitig
- Kupplungsaufnahmen nach NEM 362 beidseitig

Die Schüttgutwagen der Gattung Taoos

Die Vorbilder der neuen Schwenkdachwagen der Gattung Taoos von Rivarossi wurden in den siebziger Jahren in Frankreich bei H.K. Porter für Eigner in vielen europäischen Ländern entwickelt und gebaut. Sie sind ein wichtiges Kapitel in der Geschichte des europäischen Güterwagenbaus und dienen primär dem Transport von witterungsempfindlichen Schüttgütern wie Quarzsand, Düngemittel oder ähnlichen Materialien. Entsprechend vielfältig waren und sind damit auch die Nutzer der Wagen sowie die damit verbunden Aufschriften an Seitenwänden. In Deutschland sind vor allem die auffällig gelb lackierten „Josera“-Wagen bekannt geworden. Die charakteristischen Merkmale dieser Wagen sind ihre großen Behälter mit einem Volumen von etwa 65 m³ und die schwenkbaren Dächer, die das einfache Beladen von oben ermöglichen und gleichzeitig Schutz vor Regen und anderen Umwelteinflüssen bieten.

Durch die mittig angeordneten Entladevorrichtungen ist eine schnelle und effiziente Entladung auf speziellen Entladegleisen möglich. Die Wagen laufen auf Drehgestellen des Typs Y25 und sind für den grenzüberschreitenden Verkehr ausgelegt. Obwohl sie inzwischen teilweise durch modernere Bauarten ersetzt wurden, sind diese Wagen nach wie vor in ganz Europa im Einsatz..

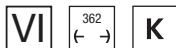
NEW**HR6547**

D-VTGCH, set di 2 carri tramoggia a 4 assi Taoos, livrea grigia
 D-VTGCH, 2-tlg. Set 4-achs. Schwenkdachwagen Taoos, in grauer Farbgebung
 D-VTGCH, coffret de 2 wagons trémie à 4 essieux Taoos, livrée gris
 D-VTGCH, set de dos vagones tolva tipo Taoos, decoración gris
 D-VTGCH, 2-unit set of 4-axle hopper wagons Taoos, grey livery

Passende AC-Tauschradsätze: HC6100 (10.27 x 25.20 mm)

Fotomontaggio / Fotomontage / Photomontage / Fotomontaje



HR6676

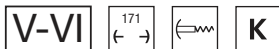

Carro tramoggia per trasporto cereali a pareti curve a 4 assi "Tucher", livrea azzurro chiaro

4-achs. Getreidesilowagen „Tucher“, hellblaue Farbgebung

Wagon céréalière à parois bombées à 4 essieux « Tucher », livrée bleu clair

Vagón tolva para cereales redondeado de 4 ejes "Tucher", decoración azul claro

4-axle round-sided cereal hopper wagon "Tucher", light blue livery

NEW

Passende AC-Tauschradsätze: HC6100 (10.27 x 25.20 mm)

Getreide gehört auf die Schiene!

Für den Transport des Getreides zur Mälzerei führt der Weg oft über die Schiene, speziell bei den größeren Brauereien. Unser neues Rivarossi-Modell ist ein solcher Getreidesilowagen, verziert mit der Werbung der bekannten Nürnberger Brauerei Tucher.



HR6677

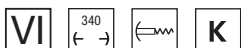

I-ERSA, set di 2 carri tramoggia per trasporto cereali a pareti piane "MONFER", livrea grigia con nuove iscrizioni

I-ERSA, 2-tlg. Set Getreidesilowagen „MONFER“, graue Farbgebung mit neuen Beschriftungen

I-ERSA, coffret de 2 wagons à trémies à parois plates « MONFER », livrée grise avec nouvelles inscriptions

I-ERSA, set de 2 tolvas para cereales de lados planos "MONFER", decoración gris con nuevas inscripciones

I-ERSA, 2-unit set of flat-sided cereal hoppers "MONFER", grey livery with new inscriptions

NEW

Assi sostitutivi per corrente alternata: HC6100 (10.27 x 25.20 mm)

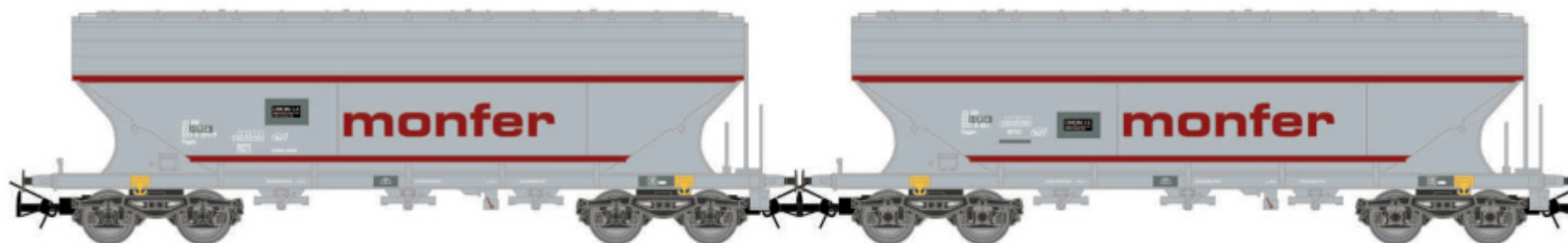

Rivarossi

HR6678

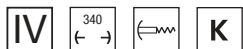

FS, set di 2 carri tramoggia a pareti piane tipo Uas, livrea "Pagnan"

FS, 2-tlg. Set Getreidesilowagen der Bauart Uas, „Pagnan“

FS, coffret de 2 wagons à trémies à parois plates type Uas, livrée « Pagnan »

FS, set de 2 wagones tolva de lados planos tipo Uas, decoración "Pagnan"

FS, 2-unit flat-sided set of hopper wagons type Uas, "Pagnan" livery

NEW

Assi sostitutivi per corrente alternata: HC6100 (10.27 x 25.20 mm)

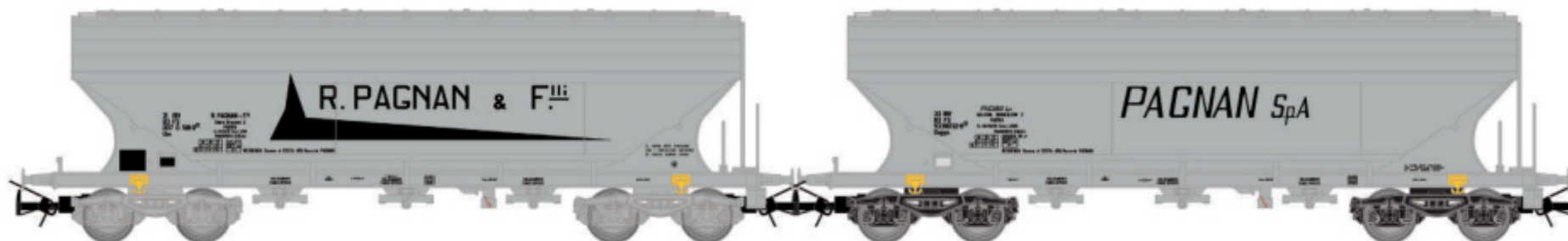

HR6679

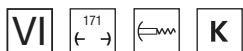

Carro tramoggia per trasporto cereali a 4 assi "Trasporto Malto 100% Italiano per PERONI"

4-achs. Getreidesilowagen „Trasporto Malto 100% Italiano per PERONI“

Wagon à trémies pour céréales à 4 essieux « Trasporto Malto 100% Italiano per PERONI »

Vagón tolva para cereales de 4 ejes "Trasporto Malto 100% Italiano per PERONI"

4-axle cereal hopper wagon "Trasporto Malto 100% Italiano per PERONI"

NEW

Assi sostitutivi per corrente alternata: HC6100 (10.27 x 25.20 mm)

Grano per la malteria

Il grano viene spesso trasportato alla malteria su rotaia, soprattutto per i grandi birrifici. Il nostro nuovo modello Rivarossi è un carro silo per l'orzo, decorato con la pubblicità del noto birrificio Peroni.



HR6680

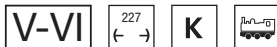

DB AG, carro telonato a 4 assi tipo Rils "RAILION DB LOGISTICS", livrea rossa con graffiti

DB AG, 4-achs. Schiebeplanenwagen „RAILION DB LOGISTICS“, Typ Rils, rote Farbgebung mit Graffiti

DB AG, wagon bâché à 4 essieux type Rils « RAILION DB LOGISTICS », livrée rouge avec graffiti

DB AG, vagón con lona de 4 ejes tipo Rils "RAILION DB LOGISTICS", decoración roja con grafitis

DB AG, 4-axle tarpaulin wagon "RAILION DB LOGISTICS", Rils type, red livery with graffiti

Fotomontaggio / Fotomontage / Photomontage / Fotomontaje



Passende AC-Tauschrsätze: HC6100 (10.27 x 25.20 mm)

NEW

HR6681

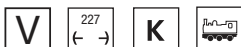

SBB, carro telonato a 4 assi tipo Rils, livrea con graffiti

SBB, 4-achs. Schiebeplanenwagen, Typ Rils, graue Farbgebung mit Graffiti



SBB, wagon bâché à 4 essieux type Rils, livrée avec graffiti

SBB, vagón con lona de 4 ejes tipo Rils, decoración con grafitis

SBB, 4-axle tarpaulin wagon, Rils type, livery with graffiti

Fotomontaggio / Fotomontage / Photomontage / Fotomontaje



Passende AC-Tauschrsätze: HC6100 (10.27 x 25.20 mm)

NEW

HR6684

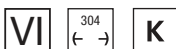

TRANSFESA/Hispanauto, carro trasporto auto a 3 assi tipo Laeks "Mega Car Carrier", livrea blu con nuovo logo

TRANSFESA/Hispanauto, 3-achs. Autotransporter Laeks „Mega Car Carrier“, blaue Farbgebung mit neuem Logo

TRANSFESA/Hispanauto, wagon transporteur de voitures à 3 essieux type Laeks « Mega Car Carrier », livrée bleue avec nouveau logo

TRANSFESA/Hispanauto, vagón portacoche de 3 ejes Laeks "Mega Car Carrier", decoración azul con nuevo logotipo

TRANSFESA/Hispanauto, 3-axle car transporter Laeks "Mega Car Carrier", blue livery with new logo

Fotomontaggio / Fotomontage / Photomontage / Fotomontaje



Assi sostitutivi per corrente alternata: HC6103

NEW

Ancora disponibili • Bereits lieferbar • Encore disponibles • Aún disponibles • Still available

*I prodotti segnalati come "ancora disponibili" potrebbero essere disponibili in quantità limitata o già esauriti
Die als „bereits lieferbar“ gekennzeichneten Produkte könnten in begrenzter Menge verfügbar sein oder bereits ausverkauft sein
Les produits indiqués comme « déjà disponibles » pourraient être disponibles en quantité limitée ou déjà épuisés
Los productos marcados como « aún disponibles » pueden estar disponibles en cantidad limitada o ya agotados
Products marked as "still available" may be available in limited quantity or already sold out*



HR2789/HR2789S

FS, locomotiva a vapore Gr. 835, fanali elettrici, pompa Westinghouse piccola, ep. III-IV



- Primo modello Rivarossi con fanali elettrici funzionanti;
- Nuovi particolari riportati su panconi e caldaia per un maggiore realismo;
- Nuove numerazioni e varianti inedite;
- Nuovo telaio con nuova motorizzazione.



HR2807

KPEV, Dampflokomotive G 8.1, in grün/schwarzer Lackierung, Ep. I



HR2808/HR2808S

DRG, Dampflokomotive BR 55.25 (ex pr. G 8.1), in schwarz/roter Lackierung, Ep. II



HR2809

DB, Dampflokomotive BR 55.25 (ex pr. G 8.1), in schwarz/roter Lackierung, Ep. III



HR2810

DR, Dampflokomotive BR 55.25 (ex pr. G 8.1), in schwarz/roter Lackierung, Ep. IV



 **HR2854/HR2854S**

ÖBB, Elektrolokomotive 1046 009-5, in
"Valousek"-Lackierung, Ep. IV-V



 **HR2855/HR2855S**

ÖBB, Elektrolokomotive 4061.17, in blutoranger
Lackierung, Ep. IV



 **HR2861HM**

Straßenbahn DUEWAG GT6, „Coca-Cola“-Lackierung,
Ep. IV-V, mit HM7000-Bluetooth-Decoder



 **HR2889/HR2889ACS/
HR2889S**

DB, Dampflokomotive Baureihe 56.20, dreidomiger
Kessel, in schwarz/roter Lackierung, Ep. III



- Chassis, Radsätze, Umlauf, Kessel und Tendergehäuse aus Zinkdruckguss, andere Teile aus hochwertigem, fein graviertem Kunststoff
- Fünfpoliger Hochleistungsmotor mit Schwungmassen
- Alle vier Treib- und Kuppelachsen angetrieben
- Länge über Puffer: ca. 195 mm (einstellbar)
- Mindestradius: 356,5 mm
- Mit Figuren von Lokführer und Heizer

 **HR2891/HR2891ACS/
HR2891S**

DRG, Dampflokomotive Baureihe 56.20, dreidomiger
Kessel, in schwarz/roter Lackierung, Ep. II



- Spitzenbeleuchtung mit der Fahrtrichtung wechselnd
- mit glühender (DC) bzw. flackernder (im Digitalbetrieb) Feuerbüchse
- Lok und Tender sind kurzgekuppelt (Länge einstellbar)
- Kupplungsaufnahmen nach NEM 362 beidseitig
- Digitalschnittstelle nach NEM 660 (21-pol. MTC)
- Mit Figuren von Lokführer und Heizer

 **HR2890/HR2890S**

DR, Dampflokomotive Baureihe 56.20, dreidomiger
Kessel, in schwarz/roter Lackierung, Ep. III



HR2897/HR2897S

Mercitalia Shunting & Terminal, locomotiva diesel da manovra EffiShunter 1000, livrea rossa/grigia con strisce bianche, ep. VI



- Lunghezza fuori respingenti 189 mm
- Modello motorizzato in corrente continua (versioni S con decoder DCC sound)
- Presa per decoder NEM 652
- Modello con illuminazione interna
- Gancio corto con cinematismo a norma NEM
- Motore con volano
- Locomotiva con luci reversibili bianche e rosse

HR2898/HR2898S

Rail Traction Company, locomotiva diesel da manovra EffiShunter 1000, livrea bianca/nera, ep. VI



HR2900/HR2900S

Mercitalia Rail, locomotiva diesel da manovra EffiShunter 1000, livrea argento con strisce rosse, ep. VI



HR2904/HR2904S

FS, locomotiva elettrica E.402B, nuova livrea "Frecciabianca", ep. VI



- Modelli motorizzati in corrente continua oppure con decoder digitale sonoro installato di fabbrica (versioni S)
- Motore con volani e trasmissione a doppio albero cardanico su tutte le ruote di entrambi i carrelli
- Luci bianche di testa e rosse di coda con commutazione automatica in base al senso di marcia e con possibilità di esclusione indipendente tra le due cabine
- Terzo faro con comando indipendente dai fanali bassi
- Possibilità di alimentazione da linea aerea.

HR2905/HR2905S

FS RFI, locomotiva elettrica E.402B, livrea gialla/blu, ep. VI



Scopri la locomotiva nel dettaglio con il video di Andrea Picard

HR2909/HR2909S

FS, draisina KLV 53, livrea gialla RFI, ep. V-VI



- Panconi con respingenti e fanali specifici
- Per quanto riguarda HR2909, i parapetti sono alti ai lati della gru

HR2910/HR2910S

Draisina KLV 53, livrea gialla, "Sirti", ep. V



- Gru mobile liberamente posizionabile sulla parte posteriore
- Gancio con accoppiamento magnetico conduttivo di corrente



Photo: Marco Buono



HR2912/HR2912D/ HR2912S

DB, Rottenkraftwagen KLV 53 in gelber Lackierung, Ep. IV



- Vollständige Neukonstruktion
- Viele angesetzte Details
- Feine Speichenradsätze aus Metallspritzguss
- Frei beweglicher Kran am Heck des KLV
- Spitzenbeleuchtung mit der Fahrtrichtung wechselnd (nicht bei allen Modellvarianten)

HR2913/HR2913D/ HR2913S

BASF, Rottenkraftwagen KLV 53 in grüner Lackierung, Ep. V



- 18-polige Digitalschnittstelle nach NEM 662
- Bestellnummern, die mit „D“ enden, sind ab Werk mit Digitaldecoder ausgestattet
- Bestellnummern, die mit „S“ enden, sind ab Werk mit Sound ausgestattet
- Stromführende Magnetkupplung zwischen KLV und Anhänger



HR2917/HR2917S

FS, locomotiva a vapore Gr. 835 con fanali a petrolio, ep. III



- Lunghezza fuori respingenti 108 mm
- Motore con volano
- Locomotiva con luci reversibili bianche e rosse
- Impianto elettrico con presa decoder Next18 e predisposizione per impianto sonoro con altoparlante "sugar cube"
- Decoder DCC Sound ed altoparlante di serie (versioni "S")

- Luci con opzione "modalità di manovra" sempre accese in entrambi i sensi di marcia
- Portagancio anteriore con innesto a norma NEM 362
- Fanali elettrici funzionanti
- Nuovi particolari riportati su panconi e caldaia per un maggiore realismo

HR2918/HR2918S

FS, locomotiva a vapore Gr. 835, con lampade elettriche e cerchioni bianchi, ep. III-IV



HR2920/HR2920S

DB/NorthRail, Diesellokomotive Vossloh DE 18 in grauer Lackierung, Ep. VI



- Vollständige Neuentwicklung
- Chassis aus Zinkdruckguss, Gehäuse aus hochwertigem, fein graviertem Kunststoff
- Fünfpoliger Hochleistungsmotor mit Schwungmassen
- Alle vier Achsen angetrieben
- Stromabnahme über alle Räder der Lokomotive
- Länge über Puffer: 195 mm

HR2921/HR2921S

RailAdventure, Diesellokomotive Vossloh DE 18 in grauer Lackierung, Ep. VI



- Mindestradius: 356,5 mm
- Spitzenbeleuchtung mit der Fahrtrichtung wechselnd
- Rote Schlussleuten mit der Fahrtrichtung wechselnd und im Digitalbetrieb separat schaltbar
- Innenbeleuchtung im Führerhaus
- Kurzkupplungskulissen beidseitig
- Kupplungsaufnahmen nach NEM 362 beidseitig
- Digitalschnittstelle nach NEM 660 (21-pin MTC)



HR2928/HR2928S

AWT, locomotiva diesel classe D.753.7, livrea arancio/grigia, ep. V-VI



HR2928

HR6589-1

HR6589-2

HR6589-3

HR6590-1

HR6590-2

HR6590-3

HR2929/HR2929S

 HUPAC, locomotiva diesel classe D.753.7, livrea rossa/grigio chiara, ep. V-VI



HR2930/HR2930S

Mercitalia Shunting & Terminal, locomotiva diesel classe D.753, livrea rossa/grigia con strisce bianche, ep. VI



HR2931/HR2931S

FS, locomotiva diesel da manovra gruppo 245, senza corrimani laterali, livrea verde con strisce gialle, ep. IV



HR2932/HR2932S

Mercitalia Shunting & Terminal, locomotiva diesel da manovra gruppo D.245, livrea rossa/grigio scura con strisce bianche, ep. VI



HR2933/HR2933S

FS, locomotiva elettrica E.645, 1a serie, livrea castano/Isabella con logo FS semplificato, pantografi 52, ep. IV-V



- Praticabile modificato per la versione d'origine senza corrimani laterali
- Trasmissione ad ingranaggi su tutti gli assi
- Decoder con presa Next18
- Altoparlante "sugar cube" per un audio nitido
- Versioni S con suoni realistici specifici per la locomotiva
- Fanali con illuminazione invertita a seconda del senso di marcia; modalità manovra digitale con luci accese su entrambe le testate
- Accessori extra per allestire i frontali in modo realistico, inclusi in bustina



Scopri la locomotiva nel dettaglio con il video di Andrea Picard



HR2934/HR2934S

FS, locomotiva elettrica E.645, 1a serie, livrea castano/Isabella con logo FS semplificato, pantografi 42U, ep. IV-V



HR2935/HR2935S

FS, locomotiva elettrica E.645, 1a serie, livrea Isabella con logo FS rosso semplificato, pantografi 52, ep. V



HR2936S

FS, locomotiva elettrica E.636, 3a serie, senza gocciolatoio frontali, livrea Isabella, ep. V



HR2938/HR2938S

ÖBB, Elektrolokomotive 1040 003, blutorange Lackierung mit Zierlinie, Ursprungslüfter, Flachdach, Trittstufen, Ep. V



HR2939/HR2939S

ÖBB, Elektrolokomotive 1040.10, neue seitliche Lüftungsgitter, grüne Lackierung, mit Bremswiderständen auf dem Dach, Ep. IV



HR2940/HR2940S

ÖBB, Elektrolokomotive 1040 007-5, neue seitliche Lüftungsgitter, blutorange Lackierung mit drei Zierlinien, niedriges Dach, Rangiertritte vorn und hinten, Ep. V



- Das Rivarossi-Modell HR2938 wird von einem schräg genuteten Fünfpolmotor mit Schwungmassen auf alle vier Achsen angetrieben
- Dies sorgt für beste Fahreigenschaften
- An Bord sind eine Digitalschnittstelle nach NEM 662 (Next-18), Stromabnahmekontakte an allen acht Rädern, gefederte Puffer aus Metall, stabile aber dennoch filigrane Stromabnehmer sowie angesetzte Griffstangen aus Metall
- Der Sécheron-Federantrieb ist vorbildgerecht auf die Radscheiben graviert
- Die Sound-Variante HR2938S wird mit einem ZMO-Sounddecoder geliefert
- Die Sounds wurden eigens für Rivarossi aus einzigartigen Tonaufnahmen der Reihe 1040 der ÖBB erstellt



 **HR2943/HR2943HM**

Straßenbahn, Typ DUEWAG GT8, Version Graz in grün/beiger Lackierung, Ep. IV-V



 **HR2945HM**

Straßenbahn, Typ M6, Version Nürnberg in rot/weißer Lackierung, Ep. IV-V



 **HR2956/HR2956S**

FS, locomotiva a vapore Gr. 940, con fanali a petrolio, ep. III



 **HR2957/HR2957S**

FS, locomotiva a vapore Gr. 940, con fanali elettrici, ep. III-IV



Fanali elettrici



Fanali a petrolio

- Nuovi dettagli su caldaia, cabina e sottocassa differenziati in base all'epoca per riprodurre coerentemente la configurazione delle macchine nel periodo di ambientazione prescelto
- Numerazioni inedite

- Nuovo impianto elettrico con interfaccia per decoder Next18
- Nuovo impianto sonoro, con altoparlante "sugar cube" 11x15 mm
- Versioni DCC Sound di fabbrica, mai prodotte in precedenza
- Nuova riproduzione della traversa completa del carrello anteriore



Re 4/4 der BLS

Gipfelstürmer

HR2958ACS/HR2958S

BLS, vierachsige elektrische Mehrwecklokomotive Re 4/4 167 „Ausserberg“, braun, Ep. IV-V



HR2959/HR2959S

BLS, vierachsige elektrische Mehrwecklokomotive Re 4/4 181 „Interlaken“, braun, Ep. IV



HR2960/HR2960S

BLS, vierachsige elektrische Mehrwecklokomotive Re 4/4 191 „Reichenbach“, mit Einholmstromabnehmer, braun, Ep. IV-V



Die BLS Ae 4/4II wurde von 1964 bis 1983 als Universallokomotive mit guter Bergleistung beschafft, um die Züge mit höheren Geschwindigkeiten befördern zu können und um die Lokomotiven der Gründungsjahre abzulösen.

Aufgrund der sehr erfolgreichen Konstruktion der Ae 4/4 der BLS, der ersten laufachslosen Hochleistungslokomotive der Welt, leiteten die BLS und SLM die Neuentwicklung von dieser Reihe ab.

Die ersten fünf Maschinen waren bei Ablieferung nur für 125 km/h zugelassen und wurden dementsprechend Ae

4/4II 261–265 bezeichnet. 1969 wurden sie nach Änderung der Kastenabstützung auf Schraubenfedern und ausgedehnten Versuchsfahrten für die Reihe R zugelassen und die Höchstgeschwindigkeit auf 140 km/h hinaufgesetzt. Seither tragen die Lokomotiven die Bezeichnung Re 4/4 161–165.

Die neue Rivarossi-Modelle kommen anlässlich des 60. Jubiläums der Re 4/4 in einer eleganten Verpackung aus Karton mit Chromaufschrift und Metall, welche neben einem Booklet zur Geschichte dieser erfolgreichen Lokomotive auch einen silbernen Schlüsselanhänger aus Metall in Form

einer BLS Re 4/4 enthält.

Die Modelle selbst werden in den Analogversionen mit Next-18-Schnittstelle und im Digitalbetrieb zuschaltbarer Führerstandsbeleuchtung geliefert. Sie sind nicht mit Sound nachrüstbar. Die Versionen mit Sound sind bereits ab Werk mit Sound und „Decoder on board“ ausgerüstet. Für die Lokomotivgeräusche wurden ausschließlich Originalaufnahmen der BLS Re 4/4 verwendet.

Neben der Führerstandsbeleuchtung besitzen die Soundvarianten auch jeweils eine sogenannte „Powerbank“ mit der selbst größere Stromunterbrechungen von mehreren Sekunden am Gleis überbrückt werden.



Hochwertige Verpackung mit Chromaufschrift und Metallbox



Booklet zur Geschichte dieser erfolgreichen Lokomotivbaureihe



Schlüsselanhänger aus Metall in Form einer Re 4/4 der BLS

HR2969/HR2969S

FS Mercitalia S&T, locomotiva diesel Vossloh DE 18, livrea grigia, ep. VI



- Progetto completamente nuovo
- Telaio in metallo pressofuso, carrozzeria in plastica finemente incisa di alta qualità
- Motore a cinque poli ad alte prestazioni con volani
- Quattro assi motorizzati
- Presa di corrente attraverso tutte le ruote della locomotiva
- Lunghezza fuori respingenti: 195 mm
- Raggio minimo: 356,5 mm
- Fanali di testa con commutazione a seconda del senso di marcia
- Luci rosse di coda con commutazione a seconda del senso di marcia, con possibilità di comando indipendente in modalità digitale
- Illuminazione interna della cabina

- Illuminazione del cruscotto sul banco di manovra in cabina
- Timoni di allontanamento su entrambe le testate
- Portagancio NEM 362 su entrambe le testate
- Interfaccia digitale a 21 poli NEM 660 (21MTC)
- Riproduzione di griglie e pannelli degli avancorpi specifici per la versione italiana della DE 18

- Cabina con porta a destra e banco di comando a sinistra in entrambi i sensi di marcia
- Captatori SSC sul ricasso del tetto della cabina
- Riproduzione del carica batterie e delle apparecchiature sottocassa specifici per la versione italiana
- Tutte le scritte di servizio coerenti con la versione riprodotta

HR2970/HR2970D

DB AG, ASF (Akku-Schleppfahrzeug) 383 001-5, grüne Farbgebung, Ep. V



HR2971/HR2971D

DB AG, 2-tlg. Set ASF (Akku-Schleppfahrzeuge) „DB Regio Gießen“ in roter und blauer Farbgebung mit Blinklichtern, Ep. V-VI



 **HR4324**

FS, set di 4 carrozze "Treno Azzurro", composto da 2 carrozze di 1a classe tipo 1946 Az13010 e 2 carrozze di 2a classe tipo 1946 Bz33010, una con scompartimento ristoro, ep. IIIb. Assi sostitutivi per corrente alternata: HC6102 (10,50 x 24,50 mm)



 **HR4326**

FS, set di 3 carrozze, composto da 1 carrozza di 1a classe tipo 1946 Az13010 e 2 carrozze di 3a classe tipo 1946 Cz33010, livrea castano/isabella, ep. III. Assi sostitutivi per corrente alternata: HC6102 (10,50 x 24,50 mm)



 **HR4333**

CIWL, Schlafwagen der Bauart MU, matriculated in the fleet of the DB, period IV



 **HR4334**

SBB, carrozza letti MU '64 WMD con carenature grandi, livrea TEN con tetto in alluminio, ep. IV



- Lunghezza fuori respingenti 303 mm
- Modello con dettagli interni
- Gancio corto con cinematismo a norma NEM
- Respingenti molleggiati
- Assi sostitutivi per corrente alternata: HC6100 (10.27 x 25,20 mm)

 **HR4351**

FS, set di 2 carrozze Gran Confort '85 "Progetto 901" di 1a classe, livrea Frecciabianca con porte rosse, ep. VI Passenger Coach Packs



 **HR4354**

FS, set di 2 carrozze salone Gran Confort 1985, livrea XMPR, composto da 1 carrozza A e 1 carrozza AH per trasporto disabili, ep. V-VI



HR4355

FS, set di 2 carrozze UIC-Z1 "Progetto 901" di 2a classe, livrea Frecciabianca con porte rosse, ep. VI



HR4358

FS, set di 3 carrozze IC 572/579 "Petruzzelli", Milano - Bari, livrea Bandiera, composto da 1 carrozza salone Gran Confort 1985, 1 carrozza a scompartimenti Gran Confort 1985 e 1 carrozza ristorante Gran Confort WR83 con tetto liscio, ep. V



HR4359

FS, set di 3 carrozze IC 507/530 "Sila", Torino - Reggio Calabria, livrea "Intercity Plus", composto da 2 carrozze salone Gran Confort 1985 e 1 carrozza ristorante Gran Confort WR83 con tetto liscio, ep. Vb



HR4361

 FS, set di 3 carrozze "Alpen-Express", composto da 1 carrozza ristorante WR CIWL 1925T, 1 carrozza di 1a classe UIC-X in livrea rossa/grigia e 1 carrozza UIC-X di 2a classe in livrea grigia, ep. IVb



- Nuovi stampi per cassa, vetri e telaio della WR 1925T "Pistoiesi", una tipologia di carrozza mai realizzata prima da Rivarossi
- Riproduzione dettagliata di apparecchiature sottocassa, tetto, testate ricostruite e dettagli sulle fiancate
- Interni accuratamente modificati
- Versione con testate ricostruite e intercomunicanti tubolari
- Carrelli M4p
- Livrea CIWL con iscrizioni in italiano, senza emblema CIWL
- Cinematismo di aggancio corto a norma NEM 362
- Respingenti molleggiati
- Targa "Trattoria" in fotoincisione inclusa
- Disponibili in 1ª o 2ª classe, tipi 1968, 1975 o 1982, con livrea rosso fegato o grigio ardesia a seconda della versione
- Bagagliaio Tipo 1970 in livrea grigio ardesia con porte originali (HR4362), una novità assoluta
- Nuovi predellini sulle porte di salita
- Freni a disco riprodotti sui carrelli

HR4362

 FS, set di 3 carrozze "Alpen-Express", composto da 2 carrozze UIC-X di 2a classe in livrea rossa/grigia e 1 bagagliaio UIC-X '70 in livrea grigia, ep. IVb



HR2966

HR4362-1

HR4361-3

HR4361-1



HR4361-2

HR4362-2

HR4362-3

HR4360

FS, set di 3 carrozze "Rapido 904-905", composto da 1 carrozza ristorante CIWL WR 1925T, 1 carrozza di 1a classe UIC-X '68 e 1 carrozza di 2a classe in livrea grigia con striscia rossa, ep. IVa



- Nuovi stampi per cassa, vetri e telaio della ristorante WR 1925T "Pistoiesi", tipologia di carrozza mai prodotta in precedenza da Rivarossi
- Riproduzione dettagliata delle nuove apparecchiature sottocassa, del tetto, delle testate ricostruite e dei dettagli sulle fiancate
- Interni coerentemente modificati
- Versione con testate ricostruite ed intercomunicanti tubolari
- Carrelli M4p
- Livrea CIWL con emblema a centro cassa e fascia rossa "alta velocità" indicante l'abilitazione ai 180 km/h

- Cinematismo di aggancio corto a norma NEM 362
- Targhe di percorrenza specifiche in fotoincisione fornite in bustina
- Carrozze tipo 1968 con carrelli MDfd di 1^a o 2^a classe
- Livrea grigio ardesia con fascia rossa "alta velocità" indicante l'abilitazione ai 180 km/h
- Nuovi predellini sulle porte di salita
- Nuova riproduzione dei freni a disco sui carrelli
- Numerazioni inedite

 **HR4365**

FS, set di 3 carrozze, livrea castano, composto da 1 bagagliaio Dz 83000, 1 carrozza di 1a classe Az 13010 tipo 1946 e 1 carrozza di 2a classe Bz 33010 tipo 1946, ep. IIIb



 **HR4366**

FS, set di 2 carrozze, livrea grigia, composto da 1 bagagliaio per trasporto biciclette Dz 83000 e 1 carrozza di 2a classe Bz 33010 tipo 1946, ep. IVb



 **HR4368**

FS, set di 2 carrozze Tipo 1946, composto da 2 carrozze di 2a classe Bz 33010, una con comparto ristoro, livrea grigio ardesia, marcatura FS, ep. III-IV



 **HR4367**

FS, set di 2 carrozze, livrea castano/Isabella, composto da 1 carrozza di 2a classe con scompartimento ristoro Bz 33010 tipo 1946 e 1 carrozza di 2a classe Bz 33010, ep. IIIb



 **HR4369**

FS, set di 3 carrozze a 2 assi "Corbellini" 1947 di 3a classe per treni storici, livrea castano/Isabella, ep. V-VI



 **HR4370**

FS, set di 2 carrozze "Corbellini" 1947, livrea grigia, composto da 1 carrozza a 2 assi e 1 carrozza a 4 assi, ep. IV



HR4374

 "Italien-Holland Express", set di 4 carrozze, 1 letti MU NS livrea TEN, 1 cuccetta DB Bcm 243 blu/beige, 1 UIC-X 2a cl. FS rosso fegato e 1 cuccetta UIC-X '68 FS rosso fegato, ep. V



Dettagli modello

Carrozze cuccette Bcm243 DB / UIC-X 1968 cuccette FS

Nuovi stampi per cassa, vetri, interni, sottocassa e dettagli separati. Differenze tra versioni DB, FS e tra sottoserie diverse correttamente riprodotte. Riproduzione dettagliata delle nuove apparecchiature sottocassa, del tetto, delle testate, differenziate in base al tipo di carrozza ed alla sottoserie. Interni interamente riprodotti, con cuccette aperte e scalette in fotoincisione. Nuovi predellini sulle porte di salita, differenziati in base alla sottoserie (fissi o ribaltabili). Carrelli MD36, MDfd o 24au in base alla serie della carrozza.

Carrozze UIC-X FS

Carrozze UIC-X di 2ª classe FS dei tipi 1975, 1979 o 1982 in livrea rosso fegato o grigio ardesia in base alla versione riprodotta, in numerazioni e varianti inedite. Nuovi predellini sulle porte di salita. Nuova riproduzione dei freni a disco sui carrelli.

Carrozze letti MU

Carrozze tipo MU 1973 con freni a disco, in livrea TEN con tetto blu, in carico alle Ferrovie Olandesi (NS), versione mai prodotta da Rivarossi. Nuova riproduzione dei freni a disco sui carrelli.

Per tutte le carrozze

Cinematismo di aggancio corto a norma NEM 362. Respingenti e tubolari degli intercomunicanti molleggiati, Targhe di percorrenza specifiche in fotoincisione fornite in bustina, secondo l'Orario Invernale 1993-1994.

HR4375

 "Italien-Holland Express", set di 4 carrozze, 1 cuccetta DB Bcm 243 blu/beige, 1 UIC-X 2a cl. FS rosso fegato, 1 UIC-X 2a cl. FS grigio ardesia e 1 cuccetta UIC-X '68 FS rosso fegato, ep. V



HR4376

FS, set di 2 carrozze cuccette UIC-X Tipo 1968, livrea XMPR, ep. V



Carrozze UIC-X 1968 a cuccette delle FS

Le cuccette Tipo 1968 rappresentano la prima serie di carrozze di questo tipo costruite sulla piattaforma UIC-X per le FS; derivate direttamente dalle UIC-X 1968 diurne costruite in contemporanea, ne mantengono la stessa struttura della cassa ma diversa organizzazione degli interni, presentando 10 scompartimenti per i viaggiatori più 1 per l'accudiente, con 4 lavabi oltre alle 2 ritirate. La prima sottoserie di 92 carrozze venne consegnata tra il 1968 ed

il 1970, caratterizzata dai carrelli 24au, aria soffiata di tipo Westclimat e riscaldamento a vapore, subito seguita nel 1970-71 da un'altra sottoserie di 160 carrozze identiche alla prima ma senza riscaldamento a vapore, per finire la fornitura nel 1973 con un'ultima sottoserie di 30 unità dotate di carrelli MDfd con freni a disco, che garantivano migliori qualità di marcia, ed impianto ad aria soffiata Friedmann, analogamente alle carrozze diurne della stessa serie. Nel corso degli anni, come tutte le carrozze UIC-X, hanno subito diverse modifiche come l'installazione di nuove porte in lega, gradini di salita ribaltabili ed altri aggiornamenti tecnici; anche la livrea è cambiata nel tempo, passando dall'originale grigio ardesia al rosso fegato / grigio beige negli anni '80 ed all'XMPR negli anni '90, quest'ultima mantenuta fino a fine carriera avvenuta attorno al 2010 per questa serie di carrozze.

HR4378

NightJet, 2-unit pack couchette coaches Bvcmz 248.5, blue livery, ep. VI



 **HR4371**

DR, 4-tlg. Doppelstockeinheit ohne Steuerabteil in blau/hellgrauer Lackierung, Ep. IV



 **HR4392**

DR, 4-tlg. Doppelstockeinheit mit Steuerabteil, mit grün/grauer Dach, Ep. III



 **HR4393**

DR, 4-tlg. Doppelstockeinheit ohne Steuerabteil, mit grün/grauer Dach, Ep. IV



 **HR4394**

DR, 4-tlg. Doppelstockeinheit mit Steuerabteil und gerade Frontseiten in grün/grauer Farbgebung, großes „DR“-Logo, Ep. IV



 **HR4382**

DB AG, Autotransportwagen DDM 916 in roter Lackierung, „Autozug“, Ep. IV



 **HR4383**

ZXBENET, Autotransportwagen DDM 916 mit Schutzgittern in blauer Lackierung, Ep. VI



 **HR4399**

FS, carrozza letti MU '73 in livrea TEN, tetto color alluminio, logo FS a "televisore" + logo "Railtour", ep. IV



- Carrozza letti FS tipo MU 1973 con freni a disco, in livrea TEN con loghi FS e Railtour
- Riproduzione dettagliata dei freni a disco sui carrelli
- Cinematismo di aggancio corto a norma NEM 362
- Respingenti e tubolari degli intercomunicanti molleggiati

 **HR4400**

FS, carrozza letti tipo MU '73 in livrea CIWL con emblema, ep. IV



- Carrozza letti FS tipo MU 1973 con freni a disco, in livrea CIWL con monogramma a centro cassa, variante mai prodotta in precedenza da Rivarossi per questa serie di carrozze MU
- Nuova riproduzione dei freni a disco sui carrelli
- Cinematismo di aggancio corto a norma NEM 362
- Respingenti e tubolari degli intercomunicanti molleggiati



 **HR6520**

DB AG, 3-tlg. Set 4-achs. Selbstentladewagen Fals 164, in brauner Lackierung, Ep. V



 **HR6552**

FS, carro pianale a stanti a 4 assi Res, livrea verde, ep. VI



 **HR6553**

FS, carro pianale a stanti a 4 assi Res, livrea verde, caricato con bobine di filo, ep. VI



 **HR6561**

FS, set di 3 carri refrigerati a 2 assi Hgb (2 senza garitta, 1 con), sagoma inglese, livrea bianca con striscia rossa, ep. III



 **HR6555**

FS, carro pianale a 4 assi Rgs, caricato con 2 coil container "Gruppo Bernardini" da 20 piedi, ep. V



 **HR6558**

DB, 4-achs. Containerwagen Rglns inb roter Lackierung, beladen mit 2 x 20' Coil-Container „Rheinkraft“, Ep. VI



- 1 carro con garitta tipo Hgb 1931
- 2 carri senza garitta tipo Hgb 1946 con boccole a rulli
- Livrea bianca con fascia rossa, ambientazione di epoca III
- Dettagliata riproduzione delle apparecchiature sottocassa e delle testate, differenziate in base al tipo di carro
- Gancio corto con cinematismo a norma NEM
- Lunghezza totale fuori respingenti 324 mm

HR6562

FS, set di 2 carri refrigerati a 2 assi Ifms, cassa metallica, sagoma inglese, livrea argento con striscia rossa, ep. IIIb



- Entrambi i carri tipo Hgb 1947 a cassa metallica
- Livrea argento con fascia rossa, ambientazione di epoca III
- Dettagliata riproduzione delle apparecchiature sottocassa e delle testate
- Gancio corto con cinematismo a norma NEM
- Lunghezza totale fuori respingenti 211 mm

HR6569

FS, carro telonato a 3 assi Las, livrea blu, "Ausiliare", ep. IV



- Nuovi stampi per telone e struttura di testate e telaio
- Telone riprodotto in modo estremamente realistico
- Articolazione centrale che assicura un'ottima qualità di marcia

HR6570

FS, carro telonato a 3 assi Lails, livrea grigia, "Indesit", ep. V



HR6573

FS, carro silo a 2 assi, livrea blu, "Ausiliare", ep. IV



HR6574

DB, 2-tlg. Set 2-achs. Silowagen Ucs in grauer Lackierung, „Höchst“, Ep. IV



HR6576

FS, carro porta container a 4 assi Sgnss, livrea marrone, con container "Trenitalia" da 45 piedi, ep. V-VI



 **HR6589**

PKP Cargo, 3-unit pack self discharging wagons type Fals, blue/yellow livery, ep. VI



 **HR6590**

AWT, 3-unit pack self discharging wagons type Fals, grey livery, ep. VI



 **HR6591**

DB, 2-tlg. Set 2-achs. Silowagen Ucs in grauer Lackierung „Dyckerhoff“, Ep. IV



 **HR6592**

DR-Miet, 2-tlg. Set 2-achs. Silowagen Ucs in grauer und blauer Lackierung, „VTG“, Ep. IV



 **HR6598**

FS, set di 2 carri a pareti scorrevoli Habillss, livrea XMPR, ep. V-VI



 **HR6599**

DB, 2-tlg. Set Schiebewandwagen in silberner Lackierung „Cargowaggon“, Ep. IV



HR6600

FS, carro articolato a 3 assi telonato tipo Lails, "Ausiliare Milano", ep. IV-V



HR6601

FS, carro articolato a 3 assi telonato tipo Lails, "Indesit", ep. V



HR6602

FS, carro articolato a 3 assi telonato tipo Lails, "Indesit + Ariston + Scholtès", ep. V



Scopri i tre cari articolati a 3 assi tipo Lails

HR6603

Dreiachsiger Schiebeplanenwagen Lails, „Delacher + Co“, Ep. V



Entdecken Sie den 3-achsigen Schiebeplanenwagen Typ Lails

HR6604

FS, set di 2 carri refrigerati a 2 assi Ifms con porte metalliche, sagoma inglese, livrea argento con striscia rossa, ep. IV



- Entrambi i carri tipo Hgb 1946 con cassa a doghe in legno e boccole a rulli
- Riproduzione del portellone metallico ricostruito sulle fiancate
- Livrea alluminio con fascia rossa, marcatura unificata UIC, ambientazione anni '70 (epoca IV)
- Dettagliata riproduzione delle apparecchiature sottocassa e delle testate, differenziate in base al tipo di carro
- Gancio corto con cinematismo a norma NEM
- Lunghezza totale fuori respingenti 211 mm

HR6605

FS, set di 3 carri refrigerati a 2 assi Hgb (2 senza garitta, 1 con), sagoma inglese, livrea bianca con striscia rossa, ep. III



- 1 carro con garitta tipo Hgb 1931
- 2 carri senza garitta tipo Hgb 1946 con boccole a rulli
- Livrea argento con fascia rossa, ambientazione fine anni '50-anni '60 (epoca IIIb)
- Dettagliata riproduzione delle apparecchiature sottocassa e delle testate
- Gancio corto con cinematismo a norma NEM
- Lunghezza totale fuori respingenti 324 mm

 **HR6607**

FS, set di 2 carri cisterna a 2 assi (1 con garitta, 1 senza), "Mobil", ep. III

 **HR6608**

Zweiachsiger Mineralökekesselwagen „ÖMV“ der ÖBB, Epoche III



Nach dem Zweiten Weltkrieg verblieben viele italienische Güterwagen in Österreich, darunter auch das Vorbild dieses Rivarossi-Modells. Der Wagen wurde bis in die späten sechziger Jahre von der ÖMV genutzt. Die „Österreichische Mineralölverwaltung Aktiengesellschaft“ (ÖMV) war am 3. Juli 1956 aus der „Sowjetischen Mineralölverwaltung“ (SMV) hervorgegangen, die bis 1955 von der Sowjetischen Besatzungsmacht kontrolliert wurde. Das Rivarossi-Modell besitzt feinst profilierte und dunkel vernickelte Räder, Kurzkupplungskinematiken, Kupplungsaufnahmen nach NEM 362 sowie viele, teilweise aus stabilem Metal gefertigte Ansetzteile.

 **HR6609**

Zweiachsiger Mineralökekesselwagen „ÖROP“ der ÖBB, Epoche III



Dieses Rivarossi-Modell bildet bis ins kleinste Detail einen der ÖBB-Güterwagen nach, die nach dem Zweiten Weltkrieg von den italienischen FS übernommen wurden. Der Wagen wurde dabei nicht umgebaut aber neu beschriftet. Die Druckluftbremse wurde als „unbrauchbar“ markiert. Die ÖROP war damals eine Tankstellenkette der sowjetischen Besatzungszone in Österreich. Nach dem Wechsel zur ÖMV in den fünfziger Jahren wechselte der Markenname zu ELAN, ab 1990 zu ÖMV bzw. OMV. In den sechziger Jahren existierte auch den Markennamen MARTHA. Das Rivarossi-Modell besitzt feinst profilierte und dunkel vernickelte Räder, Kurzkupplungskinematiken, Kupplungsaufnahmen nach NEM 362 sowie viele, teilweise aus stabilem Metal gefertigte Ansetzteile.

 **HR6612**

FS, set di 2 carri pianale a 4 assi composto da 1 carro Rgs caricato con 2 container da 20 piedi e 1 carro Rgmms caricato con 2 veicoli militari M113, ep. IV-V

 **HR6614**

2-unit pack Container wagon, loaded with 45' containers "P&O Ferrymasters" (blue and yellow), ep. V-VI

 **HR6616**

FS CEMAT, carro porta container a 4 assi Sgns, livrea verde, caricato con 2 coil container "Dani Trasporti" da 20 piedi, ep. V-VI



HR2930

HR6614-1

HR6614-2

HR6616

HR6615

FS CEMAT, carro porta container a 4 assi Sgns, caricato con 2 coil container "Nizzi" da 20 piedi, ep. V-VI



HR6617

FS CEMAT, carro porta container a 4 assi Sgns, livrea verde, caricato con container "Italia" da 45 piedi, ep. V-VI



HR6619

DB, 2-tlg. Set 2-achs. Gaskesselwagen mit Sonnenschutzdach, „VTG“, Ep. V



HR2930

HR6576

HR6615

HR6617

HR6618

DB, 2-tlg. Set 2-achs. Gaskesselwagen Zgs, „BASF“, Ep. IV-V



HR6620

FS, set di 2 carri cisterna a 2 assi Zgkk, "Agipgas", ep. IV



HR6621

FS, set di 2 carri cisterna a 2 assi per trasporto gas, livrea argento, "Pibigas", ep. IV



- Formneuheit
- Länge über Puffer in 242 mm
- Kurzkupplungs-Mechanik eingebaut

Due set di carri cisterna a due assi, HR6620 e HR6621. Il primo è in livrea "Agipgas", mentre il secondo è in livrea argento "Pibigas". Entrambi i set sono perfetti per un'ambientazione di epoca IV e sono una novità assoluta per Rivarossi, grazie ad un nuovissimo stampo.

Questa tipologia di carro è utilizzata generalmente per il trasporto di prodotti chimici e petrolchimici, combustibili, prodotti di riciclo e similari; sul carro è sempre indicata la tipologia di prodotto per il quale sono specializzati ed eventualmente i simboli o le sigle che ne indicano la pericolosità.

HR6622

SBB, 2-tlg. Set 2-achs. Gaskesselwagen, „Wascosa“, Ep. V



Das Set aus 2 Kesselwagen des Typs Z für den Gastransport der Schweizerischen Bundesbahnen (SBB-CFF-FFS) in weißer Farbgebung, angemietet von „Wascosa“, ist zusätzlich mit einem Sonnenschutzdach ausgestattet, um die Ladung vor Erwärmung zu schützen. Ein bisher unveröffentlichtes Modell, realisiert mit einer neuen Form.

HR6647

DB Bahnbau, 2-tlg. Set Bauwagen, beinhaltet 1 x Res beladen mit Schwellen sowie 1 x Gs, beide in gelber Farbgebung, Ep. V-VI



HR6625

DB, 4-achs. Schwenkdachwagen mit gewölbten Silowänden für den Getreidetransport, „Aurora“, Ep. V



HR6645

FS, set di 2 carri Gs, cassa a doghe in legno, uno con luci di coda, ep. IV



- Esatta riproduzione delle lanterne di coda di tipo FS
- Le luci rosse sono funzionanti, con un realistico lampeggio asincrono tra le due lanterne
- L'alimentazione è garantita da una pila a bottone all'interno del carro (non inclusa nella confezione)
- Il funzionamento delle luci di coda è controllato da un magnete (incluso nella confezione). Sulla testata del carro equipaggiato con luci di coda vi è un contatto reed nascosto subito sotto il tetto del carro. Avvicinando il magnete vicino alla fine del tetto di questo carro, il contatto reed viene attivato e le luci di coda vengono accese o spente.



HR2950

Chesapeake & Ohio, articulated steam locomotive 2-6-6-6 "Allegheny", #1601



HR2951

Chesapeake & Ohio, articulated steam locomotive 2-6-6-6 "Allegheny", #1632



HR2952

Chesapeake & Ohio, articulated steam locomotive 2-6-6-6 "Allegheny", #1653



HR6661 A-B-C-D

ATSF, sliding door boxcar "San Francisco Chief" without roof walkway, #12711-#12712-#12746-#12755



HR6662 A-B-C-D

ATSF, sliding door boxcar "Texas Chief" without roof walkway, #12801-#12821-#12844-#12850



HR6663 A-B-C-D

P&LE, plug door boxcar, light blue livery without roof walkway, #6458-#6450-#6499-#6467



HR6664 A-B-C-D

Erie Lackawanna, plug door boxcar, with roof walkway, #68398-#68439-#68360-#68386



HR6665 A-B-C-D

Northern Pacific, plug door boxcar, green livery without roof walkway, #98111-#98030-#98149-#98058



Indice • Index

Locomotive elettriche.....190

Electric locomotives.....190

Carrozze.....196

Coaches.....196

Trailer.....200

Trailer.....200



www.limamodel.com

 **Lima**[®]

LimaEXPERT[®]

LIMA è tra i più importanti marchi nel mondo del modellismo ferroviario sin dal 1946. Dieci anni fa è nata LIMA Expert, la linea di prodotti per gli appassionati di modellismo ferroviario esperti ed esigenti che hanno un occhio di riguardo anche per il budget riservato all'hobby.

Con i treni ad alta velocità ICE1 delle Ferrovie Tedesche in diverse versioni, gli elettrotreni ETR 610, le locomotive elettriche E464 e le carrozze a due piani Vivalto di Trenitalia ci siamo posti l'obiettivo di ricreare lo spirito storico del marchio, attento alle novità del mondo reale ed alla "modernità", non soltanto per il mercato italiano ma con un respiro internazionale, come è sempre stato per LIMA.

Questi modelli sono quindi dettagliati, fedeli al vero e con livree attraenti, ma allo stesso tempo robusti e "senza fronzoli", orientati al gioco ed al divertimento, caratteristiche che accomunano tutte le riproduzioni del marchio.

LIMA Expert ti introduce nel migliore dei modi nell'affascinante mondo del fermodellismo!

HL1750



DB, set di 4 unità, elettrotreno ad alta velocità ICE 1 BR 401, livrea bianca/rossa, composto da locomotiva motorizzata, locomotiva folle e 2 carrozze intermedie

DB, 4-tlg. Set elektrischer Triebzug Baureihe 401 (ICE 1) in weiß/roter Lackierung, bestehend aus 2 Triebköpfen (einer davon angetrieben) sowie 2 Zwischenwagen

DB, coffret de 4 unités, automotrice électrique ICE 1 BR 401, livrée blanche/rouge, composé de locomotive motorisé, locomotive sans motor et 2 voitures

DB, set de 4 unidades, automotor eléctrico clase 401 ICE 1, decoración blanca/roja, compuesto de locomotora motorizada, locomotora sin motor y 2 coches intermedios

DB, 4-unit set, highspeed EMU ICE 1 class 401, white/red livery, including motorized head, dummy head and 2 intermediate coaches



Start der Bundesbahn ins Hochgeschwindigkeitszeitalter

1991 begann mit dem Sommerfahrplan bei der DB das Zeitalter des ICE-Linienerkehrs. Mit ihrer Höchstgeschwindigkeit von 280 km/h und 9600 kW Dauerleistung gehörten sie damals schon zu den Stars auf den Schienen. Bald waren die eleganten Züge zwischen Hamburg und Stuttgart/München und zwischen Köln und Berlin alltäglich anzutreffen. Später verkehrten sie darüber hinaus bis nach Wien oder auch nach Zürich/Interlaken, wobei sie für letztere Ziele mit zusätzlichen Stromabnehmern nach Schweizer Vorschriften auf den Triebköpfen und auch mit den Schweizer Sicherungssystemen ausgerüstet wurden. Nach 1998 änderte sich das Erscheinungsbild geringfügig, wurde doch der Rotton des Zierstreifens von Orientrot zu Verkehrsrot geändert und der pastellviolette Streifen entfiel. Heute sind einige dieser Züge mit grünen Zierstreifen am Triebkopf unterwegs. Mittlerweile haben nach fast 30 Einsatzjahren die Züge mehrere Millionen Kilometer „auf der Uhr“, aber derzeitigen Planungen zu Folge, werden diese Züge auch nach 2030 noch im Einsatz bleiben.



Fernlicht im Digitalbetrieb separate schaltbar

HL4674

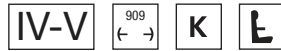

DB, set di 3 carrozze aggiuntive ICE 1 BR 401, livrea bianca/rossa, composto da 1 carrozza ristorante e 2 carrozze di 2a classe
DB, 3-tlg. Set Ergänzungsset ICE 1 Baureihe 401 in weiß/roter Lackierung, bestehend aus 1 x Speisewagen und 2 x 2.-Klasse-Wagen
DB, coffret de 3 voitures supplémentaires ICE 1 BR 401, livrée blanche/rouge, composé de 1 voiture restaurant et 2 voitures de 2ème classe
DB, set de 3 coches adicionales ICE 1 BR 401, decoración blanca/roja, compuesto de 1 coche restaurante y 2 coches de segunda clase
DB, 3-unit set of additional coaches ICE 1 BR 401, white/red livery, including 1 restaurant coach and 2 2nd class coaches



HL4677

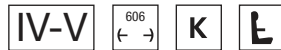

DB, set di 2 carrozze aggiuntive ICE 1 BR 401, livrea bianca/rossa, composto da 1 carrozza di 1a classe e 1 carrozza di 2a classe
DB, 2-tlg. Set Ergänzungsset ICE 1 Baureihe 401 in weiß/roter Lackierung, bestehend aus 1 x 1.-Klasse-Wagen und 1 x 2.-Klasse-Wagen
DB, coffret de 2 voitures supplémentaires ICE 1 BR 401, livrée blanche/rouge, composé de 1 voiture de 1ère classe et 1 voiture de 2ème classe
DB, set de 2 coches adicionales ICE 1 BR 401, decoración blanca/roja, compuesto de 1 coche de primera clase y 1 coche de primera clase
DB, 2-unit set of additional coaches ICE 1 BR 401, white/red livery, including 1 1st class coach and 1 2nd class coach



HL1751



DB AG, set di 4 unità, elettrotreno ad alta velocità ICE 1 BR 401, livrea bianca/rossa, composto da locomotiva motorizzata, locomotiva folle e 2 carrozze intermedie, Tz 157 "Landshut"

DB AG, 4-tlg. Set elektrischer Triebzug Baureihe 401 (ICE 1) in weiß/roter Lackierung, bestehend aus 2 Triebköpfen (einer davon angetrieben) sowie 2 Zwischenwagen, Tz 157 „Landshut“

DB AG, coffret de 4 unités, automotrice électrique ICE 1 BR 401, livrée blanche/rouge, composé de locomotive motorisé, locomotive sans motor et 2 voitures, Tz 157 « Landshut »

DB AG, set de 4 unidades, automotor eléctrico clase 401 ICE 1, decoración blanca/roja, compuesto de locomotora motorizada, locomotora sin motor y 2 coches intermedios, locomotoras y coches intermedios, Tz 157 «Landshut»

DB AG, 4-unit set, highspeed EMU ICE 1 class 401, white/red livery, including motorized head, dummy head and 2 intermediate coaches, Tz 157 "Landshut"



Das neue LIMA-Expert-Modell im Detail:

- Triebköpfe und Zwischenwagen exakt im Maßstab 1:87
- Kurzkupplungsdeichseln mit funktionsfähigen Scharfenberg-Kupplungen tauschbar (Art.-Nr. HC8040)
- Kräftiger Fünfpolmotor mit Schwungmassen
- Spitzenlicht und Schlusslichter je nach Fahrrichtung beleuchtet
- Führerstände und Zwischenwagen mit Inneneinrichtung
- Digitalschnittstelle: 21-pol MTC (NEM 660)
- Vorbereitet für den Einbau eines Rechtecklautsprechers (15x11 mm) ohne Löten
- Mindestradius: 356,5 mm (fährt jedoch besser in großzügigeren Kurvenradien)



Feine Stromabnehmer,
größtenteils aus Metall gefertigt

HL4675

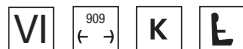

DB AG, set di 3 carrozze aggiuntive ICE 1 BR 401, livrea bianca/rossa, composto da 1 carrozza ristorante e 2 carrozze di 2a classe, Tz 157 "Landshut"

DB AG, 3-tlg. Set Ergänzungsset ICE 1 Baureihe 401 in weiß/roter Lackierung, bestehend aus 1 x Speisewagen und 2 x 2.-Klasse-Wagen, Tz 157 „Landshut“

DB AG, coffret de 3 voitures supplémentaires ICE 1 BR 401, livrée blanche/rouge, composé de 1 voiture restaurant et 2 voitures de 2ème classe, Tz 157 « Landshut »

DB AG, set de 3 coches adicionales ICE 1 BR 401, decoración blanca/roja, compuesto de 1 coche restaurante y 2 coches de segunda clase, Tz 157 «Landshut»

DB AG, 3-unit set of additional coaches ICE 1 BR 401, white/red livery, including 1 restaurant coach and 2 2nd class coaches, Tz 157 "Landshut"



HL4678

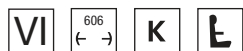

DB AG, set di 2 carrozze aggiuntive ICE 1 BR 401, livrea bianca/rossa, composto da 1 carrozza di 1a classe e 1 carrozza di 2a classe, Tz 157 "Landshut"

DB AG, 2-tlg. Set Ergänzungsset ICE 1 Baureihe 401 in weiß/roter Lackierung, bestehend aus 1 x 1.-Klasse-Wagen und 1 x 2.-Klasse-Wagen, Tz 157 „Landshut“

DB AG, coffret de 2 voitures supplémentaires ICE 1 BR 401, livrée blanche/rouge, composé de 1 voiture de 1ère classe et 1 voiture de 2ème classe, Tz 157 « Landshut »

DB AG, set de 2 coches adicionales ICE 1 BR 401, decoración blanca/roja, compuesto de 1 coche de primera clase y 1 coche de primera clase, Tz 157 «Landshut»

DB AG, 2-unit set of additional coaches ICE 1 BR 401, white/red livery, including 1 1st class coach and 1 2nd class coach, Tz 157 "Landshut"



HL2663



FS Trenitalia, set di 2 locomotive elettriche E.464 (entrambe motorizzate), livrea "Frecciabianca"

FS Trenitalia, 2-tlg. Set Elektrolokomotiven E.464 (beide motorisiert) in „Frecciabianca“-Lackierung

FS Trenitalia, coffret de 2 locomotives électriques E.464 (tous deux motorisés), livrée « Frecciabianca »

FS Trenitalia, set de 2 locomotoras eléctricas E.464 (ambos motorizados), decoración «Frecciabianca»

FS Trenitalia, 2-unit set of electric locomotives E.464 (both motorized), "Frecciabianca" livery



HL2663-1

HR4351-1

HR4351-2



HR4355-1

HR4355-2

HL2663-2

HL2664



FS Trenitalia, locomotiva elettrica E.464 464, livrea "Quattroseiquattro"
FS Trenitalia, Elektrolokomotive E.464 464 in „Quattroseiquattro“-Lackierung
FS Trenitalia, locomotive électrique E.464 464, livrée « Quattroseiquattro »
FS Trenitalia, locomotora eléctrica E.464 464, decoración «Quattroseiquattro»
FS Trenitalia, electric locomotive E.464 464, "Quattroseiquattro" livery



HL2656



FSF, set di 2 unità automotrici diesel ALn 668, livrea azzurro/grigio "Freccia Orobica", vetri curvi

FSF, 2-tlg. Set Dieseltriebwagen ALn 668, in hellblau/grauer „Freccia Orobica“-Lackierung, gewölbte Strinfenster, angetriebener Wagen

FSF, coffret de 2 automoteurs diesel ALn 668, livréé bleu/gris "Freccia Orobica", vitres bombées

FSF, set de 2 unidades, automotor diesel ALn 668, decoración azul celeste/gris "Freccia Orobica", cristales curvados

FSF, 2-unit set railcars ALn 668 light blue/grey livery, "Freccia Orobica", curved glass



HL2667



FER, set di 2 automotrici diesel ALn 668 serie 1000, livrea FER, motorizzata + folle
FER, 2-tlg. Set Dieseltriebwagen ALn 668 Serie 1000 in „FER“-Lackierung, 1 x motorisiert + 1 x unmotorisiert
FER, coffret de 2 automoteurs ALn 668 série 1000, livrée FER, motorisé + neutre
FER, set de 2 unidades, automotor diesel ALn 668 serie 1000, decoración FER, motorizado + sin motor
FER, 2-unit set of diesel railcars ALn 668 series 1000, FER livery, motorized + dummy



HL5057

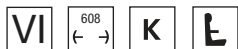

FS Trenitalia, set di 2 carrozze intermedie Vivalto, livrea DPR con vecchio logo Vivalto

FS Trenitalia, 2-tlg. Ergänzungsset Vivalto in „DPR“-Lackierung mit altem „Vivalto“-Logo

FS Trenitalia, coffret de 2 voitures intermédiaires Vivalto, livrée DPR avec ancien logo « Vivalto »

FS Trenitalia, set de 2 coches intermedios Vivalto, decoración DPR con logo «Vivalto» antiguo

FS Trenitalia, 2-unit set of Vivalto intermediate coaches, DPR livery with old “Vivalto” logo



HL5058

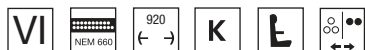

FS Trenitalia, set di 3 carrozze Vivalto, livrea Vivalto con nuovo logo Vivalto, composto da 1 carrozza pilota e 2 carrozze intermedie

FS Trenitalia, 3-tlg. Set Vivalto in „Vivalto“-Lackierung mit neuem „Vivalto“-Logo, bestehend aus 1 x Steuerwagen mit Führerstand und 2 x Zwischwagen

FS Trenitalia, coffret de 3 voitures Vivalto, livrée Vivalto avec nouveau logo « Vivalto », composé de 1 voiture pilote et voitures intermédiaires

FS Trenitalia, set de 3 coches Vivalto, decoración Vivalto con logo «Vivalto» nuevo, compuesto de 1 coche piloto e 2 coches intermedios

FS Trenitalia, 3-unit set of Vivalto coaches, Vivalto livery with new “Vivalto” logo, including 1 coach with driver’s cab and 2 intermediate coaches



HL4050

VI



FS, carrozza UIC-Z1 di 2a classe, livrea grigia/bianca "Intercity Giorno" con striscia rossa
FS, 2. Klasse Wagen UIC-Z1 in grau/weißer „Intercity Giorno“-Lackierung mit rotfarbigem Streifen
FS, voiture UIC-Z1 de 2ème classe, livrée gris/blanche « Intercity Giorno » avec bande rouge
FS, coche UIC-Z1 de segunda clase, decoración gris/blanca «Intercity Giorno» con franja roja
FS, 2nd class coach UIC-Z1, grey/white "Intercity Giorno" livery with red stripe



HL4051

VI



FS, carrozza UIC-Z1 di 2a classe, livrea blu "Intercity Notte Basic" con striscia rossa
FS, 2. Klasse Wagen UIC-Z1 in blauer „Intercity Notte Basic“-Lackierung mit rotfarbigem Streifen
FS, voiture UIC-Z1 de 2ème classe, livrée bleue « Intercity Notte Basic » avec bande rouge
FS, coche UIC-Z1 de segunda clase, decoración azul «Intercity Notte Basic» con franja roja
FS, 2nd class coach UIC-Z1, blue "Intercity Notte Basic" livery with red stripe



HC5000

Crepes Trailer



HC5001

Bratwurst Food Trailer



HC5002

Pizza Trailer



HC5003

Paella Food Trailer





Photo: Giovanni Caneparo

DIORAMA ACCESSORIES

HO 1:87



HC8021

Extension to locomotive shed

Erweiterung zum Lokschuppen
Extension pour remise à locomotives
Estensione a deposito delle locomotive
Extensión para cochera de locomotoras



HC8023

Extension for station

Erweiterung für Bahnhof
Extension pour gare
Estensione per la stazione
Extensión para estación

HC8059

Small railway station with good shed

Kleiner Bahnhof mit gutem Schuppen

Petite gare avec hangar à marchandises

Piccola stazione ferroviaria con rimessa

Pequeña estación de tren con almacén de mercancías



HC8060

Water Tank with small depot below

Wassertank mit kleinem Depot darunter

Réservoir d'eau avec petit dépôt en dessous

Serbatoio dell'acqua con piccolo deposito sottostante

Depósito de agua con pequeño almacén debajo



HC8061

Small locomotive shed

Kleiner Lokschuppen

Petit dépôt de locomotives

Piccola rimessa per locomotive

Pequeña cochera de locomotoras



HC8062

Small toilet building for railway station

Kleines Toilettengebäude für einen Bahnhof

Petit bâtiment de toilettes pour gare

Piccolo edificio per servizi igienici per stazione ferroviaria

Pequeño edificio de baños para estación de tren



HC8065

H0 Showcase display

H0 Vitrinen-Display

Vitrine d'exposition H0

Vetrina espositiva H0

Vitrina de exhibición H0



NEW

The showcase display is composed of an acrylic transparent cover + a plastic base (nice wood-style finishing).

The image featuring the locomotive is for illustrative purposes only and is not included in the box.

HC2104

Ladegut: Betonschwellen für Wagen der Bauarten Rs, Res etc. - Maße: 199 x 28 mm

Cargaison : Traverses en béton pour wagons type Rs, Res etc. - Dimensions : 199 x 28 mm

Carico: Carico di traversine in calcestruzzo per carri tipo Res, Rgs e Rs etc. - Dimensioni: 199 x 28 mm

Carga: Traviesas de hormigón para vagones tipo Rs, Res, etc. - Dimensiones: 199 x 28 mm

Load: Concrete sleepers for wagons type Rs, Res etc. - Dimensions: 199 x 28 mm

Betonschwellen

Ladegut für Wagen der Bauarten Rs, Res u.ä.

Da Holzschwellen aus einem teuren Rohstoff bestehen, wurde schon früh experimentiert, welche Materialien sich für die Unterkonstruktion eines Gleises noch bieten würden. Beton lässt sich leicht verarbeiten und bietet somit eine Reihe von Möglichkeiten der Formgestaltung. Die ersten Betonschwellen wurden bereits um 1890 eingeführt, in Deutschland begann die Erprobung von Schwellen aus Beton in den 1920er-Jahren.

In größerem Umfang wurden sie allerdings erst ab 1949 gefertigt. Bei der Bundesbahn waren bis 1974 bereits 25 Millionen Betonschwellen verbaut. Der Transport erfolgt heute meist mit standardisierten Wagen der Typen Res, Rs o.ä.

Mit etwa 199 x 28 mm passt unser neues Ladegut auf fast alle H0-Modelle dieser Güterwagen. Unsere HEICO-Schwellen sind aus hochwertigem Resin gefertigt und alle einzeln handbemalt.



HC2100

Ladegut: 4 Oberklasse-Pkw in weißem Neuwagentransportschutz

Cargaison : 4 voitures de luxe recouvertes d'une bâche blanche

Carico: 4 auto di lusso coperte da telo bianco

Carga: 4 coches de lujo con protección de transporte de vehículo nuevo, blanco

Load: 4 luxury class cars with white transport cover



Je hochwertiger der Neuwagen desto besser wird es für den Transport per Bahn und Lkw verpackt. Seit einigen Jahren gibt es dafür sogar komplett geschlossene Autotransportwagen. Doch nicht alle Wagen sind so modern oder besitzen einen ausreichenden Transportschutz. Daher hat es sich bei einigen der namhaften Autohersteller aus dem württembergischen und bayerischen Raum eingebürgert, ihre Neufahrzeuge komplett in einen weißen, maßgeschneiderten Transportschutz zu hüllen. Sogar die Felgen sind dazu mit speziellen Radkappen abgedeckt. Um die so verhüllten Pkw damit trotzdem noch auf die Autotransportwagen fahren zu können, sind in den Transportschutz lediglich Fensterausschnitte eingenäht.

Unsere HEICO-Neuwagenmodelle sind komplett aus hochwertigem Resin gefertigt und passen mit **56 x 22 mm** (Höhe: 15 mm) in bzw. auf fast alle bekannten HO-Modelle von Autotransportwagen.

HC2103

Ladegut: Drahtrollen

Cargaison : bobines de fil

Carico: bobine

Carga: rollos

Load: wire coils



Stahldraht ist ein Erzeugnis der Stahlindustrie, das in großen Mengen in alle Welt versandt wird. Von den Stahlwerken aus werden Großkunden z.B. aus der Auto- oder Bauindustrie meist mit der Eisenbahn beliefert. Oft sind ganze Züge damit beladen und auf ihrem Weg quer durch Europa zu beobachten. Meist kommen dafür Wagen der Typen Res, Rs und ähnliche Güterwagentypen zum Einsatz.

Mit etwa **205 x 29 mm** passt unser neues Ladegut auf die meisten HO-Modelle dieser Güterwagen. Unsere HEICO-Drahtrollen sind aus hochwertigem Resin gefertigt und alle einzeln handbemalt.

HC6100

Set di assi AC (4 pcs.), lunghezza dell'asse: 25,20 mm, diametro della ruota: 10,27mm, utilizzato in diversi carri con carrelli Y25 (Rivarossi, Jouef, Electrotren)

Wechselstromradsätze (4 Stück), Achslänge: 25,20 mm, Raddurchmesser: 10,27 mm, passend z.B. für viele Güterwagen mit Y25-Drehgestellen (Rivarossi, Jouef, Electrotren)

Jeu de roues pour courant alternatif (4 pcs.), Longueur de l'essieu: 25,20 mm, diamètre de la roue: 10,27 mm, utilisé sur plusieurs wagons équipés de bogies Y25 (Rivarossi, Jouef, Electrotren)

Set de ejes AC (4 pcs.), longitud del eje: 25,20 mm, diametro de la rueda: 10,27mm, utilizado en varios vagones con bogies Y25 (Rivarossi, Jouef, Electrotren)

AC wheel sets (4 pcs.), axle length: 25,20 mm, wheel diameter: 10,27 mm, e.g. fits for many wagons with type Y25 bogies (Rivarossi, Jouef, Electrotren)



HC6103

Set di assi AC (3 pcs.), utilizzato in diversi carri con tre assi (Rivarossi, Jouef, Electrotren)

Wechselstromradsätze, passend für alle unsere Autotransportwagen und Schiebeplanenwagen mit drei Achsen (Rivarossi, Electrotren, Jouef)

Jeu de roues pour courant alternatif (3 pcs.), utilisable sur plusieurs wagons porte-automobiles et wagons à bâche coulissant équipés de trois essieux (Jouef, Electrotren, Rivarossi)

Set de ejes AC (3 pcs.) para todos nuestros vagones porta-coches y vagones de plataforma con toldo corredizo de tres ejes (Electrotren, Jouef, Rivarossi)

AC wheel sets (3 pcs.), fits for all our car-transporter and tarpaulin wagons with three axles (Electrotren, Jouef, Rivarossi)



HC6101

Set di assi AC (2 pcs.), lunghezza dell'asse: 24,25 mm, diametro della ruota: 11,27mm, utilizzato in diversi carri a due assi (Rivarossi, Jouef, Electrotren)

Wechselstromradsätze (2 Stück), Achslänge: 24,25 mm, Raddurchmesser: 11,27 mm, passend z.B. für viele 2-achsige Güterwagen (Rivarossi, Jouef, Electrotren)

Jeu de roues pour courant alternatif (2 pcs.), Longueur de l'essieu: 24,25 mm, diamètre de la roue: 11,27 mm, utilisé sur plusieurs wagons à 2 essieux (Rivarossi, Jouef, Electrotren)

Set de ejes AC (2 pcs.), longitud del eje: 24,25 mm, diametro de la rueda: 11,27mm, utilizado en varios vagones de dos ejes (Rivarossi, Jouef, Electrotren)

AC wheel sets (2 pcs.), axle length: 24,25 mm, wheel diameter: 11,27 mm, e.g. fits for many 2-axle wagons (Rivarossi, Jouef, Electrotren)



HC6104

Set di assi AC (4 pcs.), lunghezza dell'asse: 24,00 mm, diametro della ruota: 11,50mm, utilizzato carrozze tedesche tipo B OSShD (Rivarossi)

Wechselstromradsätze (4 Stück), Achslänge: 24,00 mm, Raddurchmesser: 11,50 mm, passend z.B. für Reisezugwagen der Bauart OSShD, Typ B (Rivarossi)

Jeu de roues pour courant alternatif (4 pcs.), Longueur de l'essieu: 24,00 mm, diamètre de la roue: 11,50 mm, utilisé sur voitures type B allemand (Rivarossi)

Set de ejes AC (4 pcs.), longitud del eje: 24,00 mm, diametro de la rueda: 11,50mm, utilizado en coches alemanes tipo B OSShD (Rivarossi)

AC wheel sets (4 pcs.), axle length: 24,00 mm, wheel diameter: 11,50 mm, e.g. fits for German OSShD, type B coaches (Rivarossi)



HC6102

Set di assi AC (4 pcs.), lunghezza dell'asse: 24,25 mm, diametro della ruota: 10,50mm, utilizzato in carrozze tipo UIC-X (Rivarossi, Electrotren) e treni Talgo III e Pendular (Electrotren)

Wechselstromradsätze (4 Stück), Achslänge: 24,25 mm, Raddurchmesser: 10,50 mm, passend z.B. für Reisezugwagen des Typs UIC X (Rivarossi, Electrotren) sowie Talgo III und Talgo Pendular (Electrotren)

Jeu de roues pour courant alternatif (4 pcs.), Longueur de l'essieu: 24,25 mm, diamètre de la roue: 10,50 mm, utilisé sur plusieurs voitures type UIC-X (Rivarossi, Electrotren) et compositions Talgo III et Talgo Pendular (Electrotren)

Set de ejes AC (4 pcs.), longitud del eje: 24,25 mm, diametro de la rueda: 10,50mm, utilizado en coches tipo UIC-X (Rivarossi, Electrotren) así como en trenes Talgo III y Pendular (Electrotren)

AC wheel sets (4 pcs.), axle length: 24,25 mm, wheel diameter: 10,50 mm, e.g. fits for UIC X coaches (Rivarossi, Electrotren) as well as Talgo III and Talgo Pendular trains (Electrotren)



HC6105

Set di assi AC (4 pcs.), lunghezza dell'asse: 23,50 mm, diametro della ruota: 10,30 mm, utilizzato in diversi carrozze SNCF (Jouef)

Wechselstromradsätze (4 Stück), Achslänge: 23,50 mm, Raddurchmesser: 10,30 mm, passend z.B. für verschiedenen SNCF-Reisezugwagen wie Mistral '69 oder Gran Confort (Jouef)

Jeu de roues pour courant alternatif (4 pcs.), Longueur de l'essieu: 23,50 mm, diamètre de la roue: 10,30 mm, utilisé sur les voitures SNCF Mistral '69 et Gran Confort (Jouef)

Set de ejes AC (4 pcs.), longitud del eje: 23,50 mm, diametro de la rueda: 10,30 mm, utilizado en varios coches SNCF de los tipos Mistral '69 y Gran Confort (Jouef)

AC wheel sets (4 pcs.), axle length: 23,50 mm, wheel diameter: 10,30 mm, e.g. fits for many SNCF coaches like the types Mistral '69 and Gran Confort (Jouef)



HC8040

Set di quattro ganci automatici tipo Scharfenberg funzionanti; innesto a norme NEM 362 e 363, con presganciamento automatico e regolabili in altezza. Nella realtà questi ganci sono usati principalmente per automotrici, elettromotrici, metropolitane e tram. Questo gancio può essere utilizzato su tutti i modelli con innesto compatibile.

Vierteiliges Set Modellbahnkupplung nach System Scharfenberg, passend für alle Norm-Kupplungsaufnahmen nach NEM 362 und NEM 363, automatisch entkuppelbar, höhenverstellbar. Beim Vorbild werden Kupplungen dieses Typs hauptsächlich bei Triebwagen, Triebzügen, U-Bahnen und Straßenbahnen eingesetzt. Die Modellkupplungen sind universell verwendbar. Farbe: Schwarz.

Set de 4 attelages Scharfenberg. Attelages Scharfenberg fonctionnels pour boîtiers NEM 362 et 363, pré-dételage automatique, réglables en hauteur. Les attelages Scharfenberg sont utilisés en réalité sur de nombreux autorails, rames automotrices, TGV, tramways et métros. Cet attelage peut être utilisé sur tout modèle réduit équipé d'un boîtier NEM.

Set de 4 enganches tipo Scharfenberg, cumpliendo NEM 362 y 363, que puede ser desenganchado automáticamente y es ajustable en altura. En la realidad este tipo de enganches se usa en automotores, unidades múltiples, metro y tranvías. En modelismo este tipo de enganche se puede usar universalmente.





HC8006

Catenary wire, 270 mm 10-unit pack

Oberleitungs-Fahrdraht, 270 mm, 10er-Packung

Fil de caténaire, 270 mm, paquet de 10 unités

Filo di contatto della catenaria, 270 mm confezione da 10 pezzi

Cable de catenaria, 270 mm, paquete de 10 unidades



HC8007

Catenary wire, 360 mm 10-unit pack

Oberleitungs-Fahrdraht, 360 mm, 10er-Packung

Fil de caténaire, 360 mm, paquet de 10 unités

Filo di contatto della catenaria, 360 mm confezione da 10 pezzi

Cable de catenaria, 360 mm, paquete de 10 unidades



HC8034

High speed line catenary masts grey colour 10-unit pack

Schnellbahn-Streckenmast, graue Farbe, 10er-Pack
Poteaux de caténaire pour ligne à grande vitesse, couleur grise, paquet de 10 unités
Pali per la catenaria per linea ad alta velocità colore grigio, confezione da 10 pezzi
Postes de catenaria para línea de alta velocidad, color gris, paquete de 10 unidades



HC8036

Lattice catenary masts grey colour 10-unit pack

Gitter-Streckenmast, graue Farbe, 10er-Pack
Poteaux de caténaire en treillis, couleur grise, paquet de 10 unités
Pali per catenaria a traliccio colore grigio, confezione da 10 pezzi
Postes de catenaria de rejilla, color gris, paquete de 10 unidades



HC8038

Lattice catenary masts grey colour 10-unit pack

Gitter-Streckenmast in Reseda-Grün, 10er-Pack
Poteaux de caténaire en treillis, couleur vert réséda, paquet de 10 unités
Pali per catenaria a traliccio colore verde reseda, confezione da 10 pezzi
Postes de catenaria de rejilla, color verde reseda, paquete de 10 unidades



HC8035

Modern T-profile catenary masts grey colour 10-unit pack

Moderne T-Profil-Fahrleitungsmasten in grauer Farbe, 10er-Pack
Poteaux de caténaire à profilé T moderne, couleur grise, paquet de 10 unités
Pali per la catenaria a profilo T moderno colore grigio, confezione da 10 pezzi
Postes de catenaria con perfil T moderno, color gris, paquete de 10 unidades



HC8037A

Catenary mast grey colour 1 unit with connecting cable

Anschlussmast mit Kabel in grauer Farbe, 1 Stück
Poteau de caténaire couleur grise, 1 unité avec câble de connexion
Palo per la catenaria colore grigio, 1 pezzo con cavo di allacciamento
Poste de catenaria color gris, 1 unidad con cable de conexión



HC8039A

Catenary mast green colour 1 unit with connecting cable

Anschlussmast mit Kabel in grüner Farbe, 1 Stück
Poteau de caténaire couleur verte, 1 unité avec câble de connexion
Palo per la catenaria colore verde, 1 pezzo con cavo di allacciamento
Poste de catenaria color verde, 1 unidad con cable de conexión



TRACK, POWER & ACCESSORIES

The majority of this year's Hornby train sets include a smart and functional R7229 DC analogue controller, ideal for those starting out into the world of model railways, as not only does it offer smooth control both forward and reverse but also an uncontrolled auxiliary output for single point motor operation or indeed lighting.

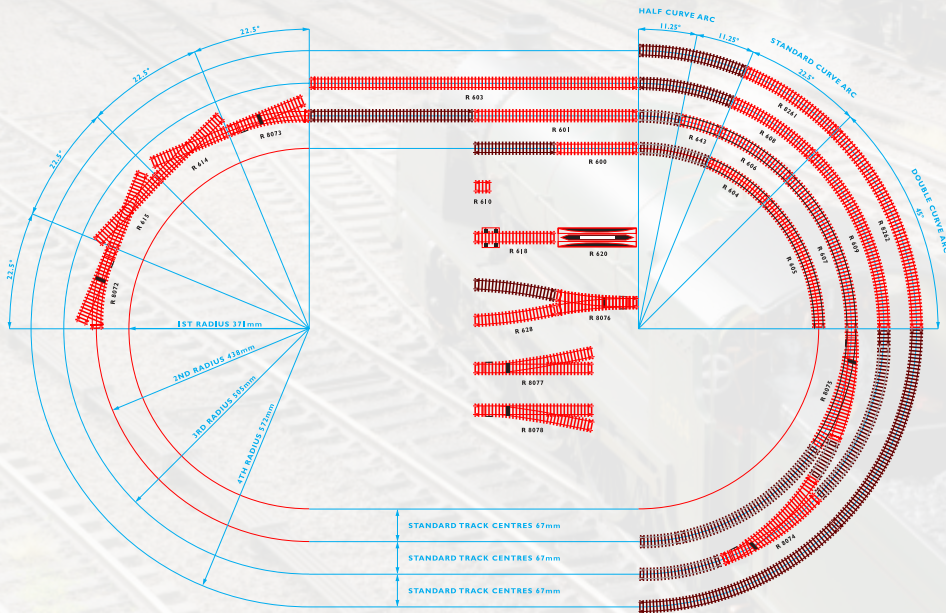

Excluding the Hornby Dublo 'Royal Scot' Set and the two Tri-ang Railways Remembered Sets the one set that does not include the R7229 controller is the exciting 'smartphone' or tablet operated 'iTraveller 6000', which features the revolutionary app based HM6000. This app allows for most 'smartphones' and tablets to control not only one circuit but initially two, with the option of adding a further three HM6000 units; eventually providing control of eight circuits in total. However, there is also one amazing part of the HM6000 and that is the Track Builder feature, which allows for schematic track designs to be created and once completed produces an itemised parts list.

For those interested in controlling the locomotives rather than the track, then Hornby DCC (Digital Command Control) would be the answer. DCC offers many advantages over regular DC Analogue Control. For example, independent control of locomotives that share the same track. Locomotives fitted with sound and steam add an extra dimension to a layout, and then there is the ease of wiring.

The benefits are both exciting and rewarding, however there is an extra cost compared to DC as each locomotive must be fitted with a decoder.

No matter whether the choice is DC or DCC, Hornby will be there to help, guide and provide.

Straight Track

	R610 Quarter Straight		R600 Straight Track
	R601 Double Straight		R603 Long Straight

Points & Flexible Track

	R614 Diamond Crossing - Left Hand		R615 Diamond Crossing - Right Hand		R8076 Y Point		R8072 Left Hand Point
	R8073 Right Hand Point		R8074 Left Hand Curved Point		R8075 Right Hand Curved Point		R8077 Left Hand Express Point
	R8078 Right Hand Express Point		R618 Double Isolating Track		R621 Flexible Track (970mm)		R8090 Semi-Flexible Track (915mm)

Curved Track

	R604 Curve - 1st Radius		R605 Double Curve - 1st Radius		R643 Half Curve - 2nd Radius		R606 Curve - 2nd Radius
	R607 Double Curve - 2nd Radius		R608 Curve - 3rd Radius		R609 Double Curve - 3rd Radius		R8261 Curve - 4th Radius
	R8262 Double Curve - 4th Radius		R628 Half Curve (33") Large Radius		R8087 Track Rubber		

Track Planning Symbols

R619 Track Planning Symbols

Before you spend money on the real track - model your track layout ideas with these quarter scale track section replicas. Sections clip together to build your layout in miniature.

Pack contains more than 100 track pieces, representing most types of section that you may use.



Track Accessories

			
R617 Uncoupling Ramp	R620 Railer/Uncoupler	R8244 Uncoupler Unit	R910 Fishplates (x 12)
			
R920 Insulated Fishplates (x 12)	R207 Track Pins	R626 Underlay Sheets (x 4)	R638 Roll of Underlay

Wheels & Coupling Hooks

			
R8098 12.6mm Spoked Wheels (x 10)	R8097 12.6mm Disc Wheels - 3 hole (x 10)	R8096 12.6mm Disc Wheels (x 10)	R8218 14.1mm Disc Wheels (x 10)
			
R8264 14.1mm Disc Wheels - 2 hole (x 10)	R8234 14.1mm Disc Wheels - 4 hole (x 10)	R8100 12.6mm Split Spoked Wheels (x 10)	R913 Con Rod Nut Spanner - Double Ended
			
R8268 Large Width Couplings (x 10)	R8267 Medium Width Couplings (x 10)	R8099 Coupling Assemblies (x 10)	R7398 Buckeye Magnetic Coupling - 8 Pairs
			
R8220 Pocket Coupling (x 10)	R8219 NEM Couplings (x 10)	R7200 Small Coupling Assembly (x 4)	R7400 Vacuum Pipe Magnetic Coupling 10mm - 8 Pairs

Rolling Road

Locomotive not included



Spare Rollers available in packs of two as R8212

R8211 Rolling Road

	R8012 HM 2000 Analogue Controller	<p>A complete transformer with built-in control for two separate trains. Power output is 2 Amps, with compensation to regularise speed under varying conditions of load. Positive 'off' rotary speed control cuts all power when the control knob is turned to zero. Features include forward and reverse switch, plus LED indicators for mains supply and output power. Outputs include non-variable AC and DC power for point motors and other powered accessories.</p>
	P9001 Standard Wall Plug Mains Transformer	<p>Replacement transformer for R8250 Standard Train Controller.</p>
	R7229 Analogue Train and Accessory Controller	<p>Note: Do not connect directly to the mains electricity supply. For use with P9000 Mains Transformer ONLY.</p>
	220-240V 50-60Hz Transformer	<p>supplying 16V AC current to R8250 and R7229 Analogue Train Controllers. Comes fitted with a 3m output lead.</p>
	R8206 Power Track	
	R602 Power Connecting Clip	
	R8201 Track Link Wire Pack	
	R8015 Point Motor Housing (Adaptor Base)	
	R044 Point Motor Passing Contact Switch - Black	
	R046 Two Way Lever Switch On/On - Yellow	
	R047 Two Way Lever Switch On/Off - Green	
	R8014 Point Motor	
	R8243 Surface Mounted Point Motor	
	R171 Single Home Signal	
	R406 Coloured Light Signal (Remote Control)	
	R172 Single Distant Signal	
	R169 Junction Home Signal	
	R170 Junction Distant Signal	



R8213 'Select' Digital Controller

Note: This controller can only access Functions F0 to F8

The Select is capable of controlling up to 59 locomotives and - providing power is available - of running up to 10 locomotives at once.

The Select can also operate 38 solenoid operated accessories, including points.

- Commands up to 10 locomotives simultaneously (providing power is available).
- The possibility of up to 3 locomotives running at any one time using the 1 amp transformer supplied.
- A 4 amp transformer is available for added power, allowing command of up to 10 locomotives simultaneously.
- Incorporates 128 speed steps for smooth locomotive control. Can be programmed to accommodate 14 and 28 speed steps.
- Able to programme 59 locomotives and 38 accessories. (The 60th locomotive would be coded as '0' and does not require a decoder).
- Supports XpressNet protocol.
- The 'Select' can also be used as a 'Walkabout' unit when connected to another Hornby 'Select' or the Hornby 'Elite' unit.
- Up to 29 locomotive functions. Can switch on and off locomotive lights and sounds including whistles, horns, etc. when used with locomotives fitted with sound decoders.



R8214 'Elite' Digital Controller

The Elite has twin, press switch controls, 17 button keyboard, wide LCD screen display, a 4 amp transformer and is capable of registering 254 locomotive addresses, as well as 255 accessory addresses, including point control.

- The 'Elite' can programme in all 4 modes: Direct, Register, Paged and Operate.
- 3 speed steps - 14, 28, 128.
- NMRA Certified. Complies with EMC requirements.
- Supports Short and Extended Addressing.
- Allows 64 consists (Double Heading).
- Controls up to 64 locomotives at any one time providing the power is available.
- The facility to operate up to 29 functions.
- Single button press for fast selection of last 10 locomotive or accessory addresses under control.
- USB for downloading system updates and for connection to third party software.
- Separate Programming and Mainline Connections.
- Locomotive search function.
- A Programmable 'scale' clock. Ratios from 1:1 (real time) up to 1:10.



R8247 Digital Accessory & Point Decoder



R7274 4 pin Decoder



R7150 Standard 6 pin Decoder



R8249 Standard 8 pin Decoder



Also available...

R7401 18 Pin Decoder - No Sound

R7402 21 Pin Decoder - No Sound

R7382 21 Pin Decoder

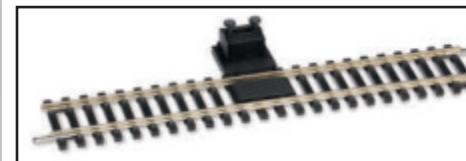

R8241

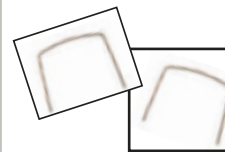

R8232



R8242



In many instances a coach fitted with lights has to rely mainly on collecting power from the track via a copper pick up strip pressing against at least one of the coach's axles or wheels. By its very nature such friction on the axle creates drag and therefore reduces the number of coaches that can be pulled behind a locomotive. For rakes of coaches being pulled by a large locomotive, for example a Pacific, this may not prove to be an issue but for a full rake of the new Mk3 coaches being pulled by a Class 43 (HST) unit such drag may affect the overall scale speed of the train but certainly not if the coaches are fitted with Hornby's Maglight system.

The Maglight system is a creative and unique development by Hornby that provides lighting in coaches with the minimum of fuss with no excessive drag because power is provided on board the coach and not by a tension pick up on the axle or wheel.

The Maglight system consists of an LCD strip, small button battery and a reed switch. Once installed the lights are switched 'on' and 'off' by just passing a 'magnet wand' over the coach roof. The small easily replaced button battery provides in excess of 200 hours of power making the Maglight system a simple but effective way of lighting coaches but with the minimum of fuss.

This unique to Hornby system is ideal for those who wish to retro fit Maglights to the majority of Hornby coaches but in particular the 4 and 6 wheel coaches, as well as the new Mk3 coaches, the installation of which is

both simple and very effective. Maglights also allow the modeller to be selective as to which coach lights are 'on' or 'off' a feature that negates the need to install expensive decoders.

Fit the MagLight system in 6 easy steps...

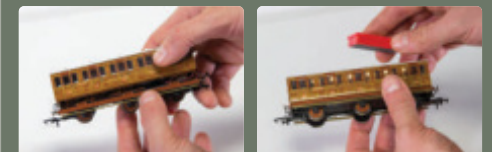
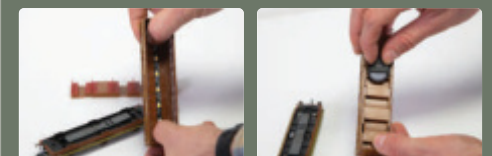
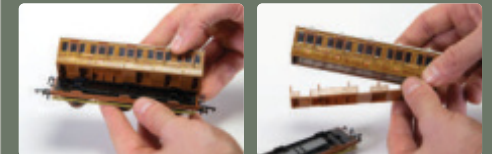

R7305 Maglight for Mk3 Coaches

R7338 Maglight Lighting Unit for 4/6 Wheel Coaches



Railway App Control

Features include...

- Features locomotive sounds including horns, whistles, steam sounds and many more
- Individual Acceleration and Deceleration controls per circuit
- Works with all major IOS or Android smart phones and tablets
- Operates locomotive, points and accessories
- Controls up to 8 separate circuits
- Intuitive layout design feature

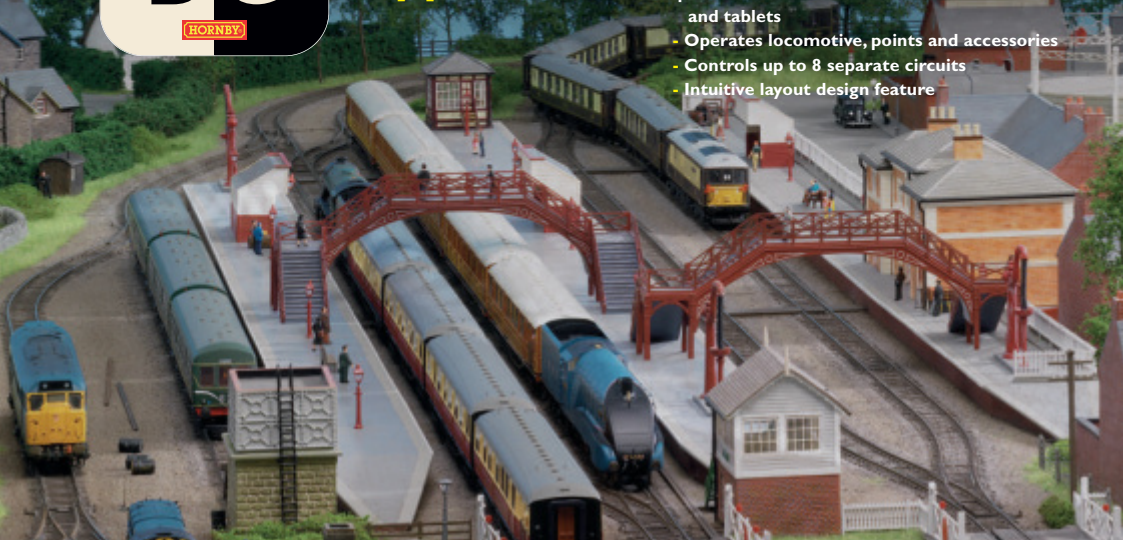

The 21st Century control system for today's 12V DC model railway.



R7293

R7292

R7293 HM6010 App Based Analogue Control

The HM6010 and the HM | DC App Control brings a wealth of new features and functions to enjoy: control point motors, signal lighting, street lighting, motor-driven accessories, turntables and conveyor belts with ease. Paired with the new HM | DC app: control up to 4 accessories (sold separately) per HM6010, control up to 12 accessories per phone or tablet with more HM6010 units (max of 3 total). Please note: Each HM6010 unit requires a transformer (sold separately), and a compatible phone or tablet is required.

R7292 HM6000 App Based Analogue Control

The HM6000 and the HM | DC App Control brings brilliant new features and functions to use: control speed, direction, acceleration, deceleration, minimum & maximum speeds, 18 in-app locomotive sounds, an emergency stop and short-circuit detection.

Also, build your dream layout with the Track Builder included with the free HM | DC app. The HM6000 is connected to the circuit using a R8206 Power Track or R602 Power Connecting Clip.

Please note: Each HM6000 unit requires a transformer (sold separately) and a compatible phone or tablet is required.

- HT8300** R600 Straight Track x 4
- HT8301** R606 2nd Radius Curve x 4
- HT8302** R8072 Left Hand Point x 1
- HT8304** R8073 Right Hand Point x 1
- P9100** UK Hornby Digital Transformer 15V 1A

HM | DC
Control literally at your fingertips.

Introducing the App based analogue control – HM6000

Technology has moved on when it comes to controlling an analogue DC layout. From now on there is no need for the controller to be tethered to the track because by using Bluetooth low energy (BLE) technology Hornby's HM6000 control system can operate a DC layout with consummate ease. The HM6000 system not only provides simple control of two circuits but also features inertia and braking control, loco sounds, minimum and maximum speed control plus an intuitive layout planning feature.

Utilising both Bluetooth Low Energy (BLE) and Bluetooth Mesh Network architecture, developed by Hornby, the HM6000 provides a stable and responsive system that becomes increasingly efficient the more a model layout develops.

Locomotive Control

The HM6000 DC application is simple and straightforward to use and includes many features not included in other DC controllers, for example the HM6000 not only controls a locomotive's speed and direction but also the braking of the model which can be incrementally applied.

By 'calling up' the Track Settings screen on the chosen smart 'phone or tablet, additional control of a locomotive can be achieved by setting the maximum and minimum speed levels of the chosen circuit.

Sounds

One of the key features of the HM6000 DC system is the inclusion of steam, diesel and electric locomotive sound profiles. Each profile has six railway based sounds allocated. For example the Steam allocation includes whistle, wheel slip, coal shovelling, braking and a Guards whistle, while the diesel features engine start up and shut down, two horns high - low and low - high,

Accessory Control

The HM6010 DC operating accessory unit provides multiple ways of controlling accessories including those that require a constant current or others that function from receiving a short burst of power. HM6010 allows the user to flick between Red, Green or Off for signal lights, On or Off for street or model house lighting plus providing constant power for accessories such as turntables.

Track Builder

Integrated into the HM|DC application is a very useful function that provides the facility to plan and build numerous layouts while at the same time listing the components required as the virtual layout takes shape.

Add, remove, snap, rotate and duplicate track pieces or sections to form large and compact layouts.

Settings

The HM6000 DC App. Has a selection of different functions or toggles that will allow for the fine tuning of each circuit.

The App. is programmed to include several languages for true international usage.

Short Circuit Detection

An innovative and rapid short circuit detection system included in the HM6000 software can quickly detect a short circuit and providing that the short has been removed, the system can once again become 'live' with a touch of a virtual button.

Device Provisioning

Both the HM6000 control and HM6010 accessory units can easily be paired with the HM | DC application through the chosen device provisioning settings, which can be found within the application.

Transformers required

For customers ordering from Europe, Australia, USA or Canada please be advised that the required transformers for each country are:

UK: P9100

Europe: P9101

Australia: P9102

The App based HM|DC system is built around two pieces of hardware which form the key elements of the set up and these are the HM6000 App Circuit Controller and the HM6010 App Operating Accessory Unit.

The HM6000 is paired with the HM|DC application on a smartphone or tablet and provides control of up to 2 circuits independent of each other. Up to 4 HM6000 units can be linked to the application which consequently provides control of 8 independent circuits via one device be it a smart 'phone or tablet.

Similarly the HM6010 is also paired with the HM DC application on a smartphone or tablet and that in turn allows for the control of up to 4 accessories be they continuous current such as used for lighting or a quick burst of power used to operate a point motor. Up to three HM6010 units can be linked to the application providing control of up to twelve accessories from one smart 'phone or tablet.

With this feature the minimum and maximum speed range setting can allow for fine tuning of a locomotive's speed by increasing the minimum start speed and in turn limiting the maximum speed.

An "Emergency Stop & Resume" function are also featured to immediately halt all circuits at the touch of a virtual button, this allowing for an effective pause time to alter settings before resuming with new settings in place.

brake squeal, flange squeal and wagons buffering. For the electric locomotive profile the sounds include start up, horn, brake, brake release, flange squeal and the Guard to Driver bell.

All these sounds are emitted from the smartphone or tablet and adds real train atmosphere to the layout.

Points and certain other accessories require a quick pulse of current and this too can be provided by the HM6010 App. These operations can be activated via the dedicated accessories screen on a smart 'phone or tablet or through using the accessory toolbar that is integrated into the circuit control screen.

Once finished, the track layout can be exported as a bill of materials to assist in building the planned layout.

The track pieces are scaled and are virtually laid on a user applied dimensioned baseboard to ensure the layout will fit.

Slider (throttle) behaviour can be set to a "drop & action" method or to "live finger swiping", which typical physical controllers would traditionally use. "App Inactivity Control" can be altered to ensure that no interruptions to your locomotives running are made by your device.

Such a function can prove to be very useful should a locomotive move from one circuit to another which may be operating with opposite polarities. Such an action will cause a short circuit which can quickly and easily be corrected by altering a directional button on the circuit control screen.

Scan Me...



...to download the **FREE** HM|DC App Today!





HM7000 HM | DCC

Features include...

- Control via FREE to download HM|DCC Bluetooth® app using a smart 'phone or tablet
- Bluetooth® technology enabling fast and wire-free Programming and Control
- Choice of Bluetooth® decoders with and without sound facility
- Bluetooth sound decoders include sugar cube speakers and variable sized sound boxes
- FREE downloadable Triplex sound profiles unique to Hornby
- Up to 25 Sounds per download
- Currently 35 plus sound files available
- All decoders offer plug-in Power Bank facility
- Hornby Bluetooth decoders are fully compatible with existing Hornby DCC controllers
- Power Bank offers up to 9 seconds of backup power
- CV editing on the layout. No need for Programming Track

Introducing Hornby HM7000 HM|DCC

Although DCC offers many advantages over conventional DC control there are still several disadvantages. With the currently available DCC systems good and consistent control relies on the command signals being passed down the track to the chosen locomotives. Any break in the command signals reaching the chosen locomotive due to poor track connections or possibly dirt on the track can result in the model stalling. This can be quite frustrating especially if the locomotive has to go through a start up sequence before moving off once more.

Changing a locomotive's CV (Configuration Variables) settings can also become a challenge as normally models have to be lifted from the track and placed on a Programming Track before CVs can be changed. Changing a locomotive's CV settings while still on the layout can result, annoyingly with all locomotives being affected by the change, however Hornby are once again on the cutting edge of innovation and operating a model railway has entered a new age of control.

The HM7000 model railway control series offers many advantages over the existing old style DCC units. Firstly, it uses an app based Bluetooth® protocol and can be downloaded on to the majority of available smart 'phones and tablets, which in turn can then be used to control a model railway. No more expensive Command Base units as the HM7000 app is totally free, just scan the HM7000 QR code and follow the instructions. It is that simple.

Secondly, there are 3 available sound decoders - 21 pin, Next 18 pin and 8 pin decoders. Each decoder is Bluetooth® enabled and is supplied complete with detachable sugar cube speaker and multi sized sound box to provide maximum depth of sound, given the available space. Initially, there are in excess of 30 free downloadable sound files to suit the more popular steam, diesel and electric locomotives with each file having in excess of 20 individual sounds.

For those who prefer to run silently, there are 4 non sound Bluetooth® decoders - 21 pin, Next 18 pin, 8 pin and 6 pin. Each of the Bluetooth® decoders, be they sound or non-sound incorporate a mini socket that allows for the fitting of an HM7070 Power Bank module. The Power Bank provides up to 9 seconds of backup power should the locomotive encounter a power outage due to dirty or poor track work.

The versatility of the new Hornby HM7000 Bluetooth® enabled control system is superbly highlighted with the numerous and low cost ways that any existing layout, either DC or DCC can be controlled using the power of the HM7000 system while wholeheartedly embracing Bluetooth® technology.



Get started with HM7000 in just four simple steps!

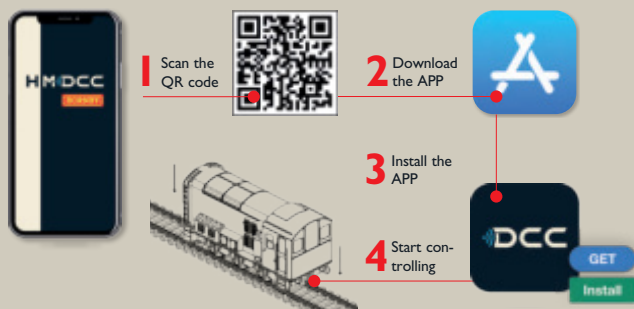

Setting up a new or converting an existing DCC system to HM7000

Train Set control - HM7000 HM|DCC

For many who enter the world of model railways they tend to start with a train set but invariably as interest grows their thoughts inevitably turn to DCC but are soon dampened by the potential cost. Not so with the HM7000 HM|DCC system. All that needs to happen to go digital is the installation of a Bluetooth® enabled Hornby non-sound decoder into a chosen locomotive. The HM7000 app can then be downloaded onto a smart device and paired with the loco. Next, the model is placed onto the track and the DC controller is moved up to full voltage. Once this is done the model can be operated via the smart device. Full DCC operation for the price of a Bluetooth decoder. No other system can offer DCC control at such an economic level.

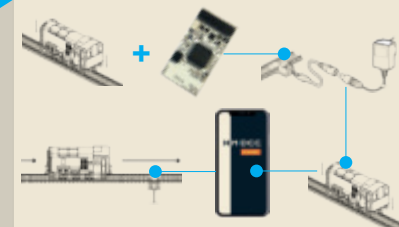

HM6000 HM|DC - HM7000 HM|DCC

The HM6000 system uses the Bluetooth® protocol and therefore any layout using this system is only a short step away from being HM7000 HM|DCC compliant.

To convert an HM6000 layout to HM7000 control there are just six simple steps that need to be taken:

- Step 1:** Download the HM|DCC app. Onto a suitable smart 'phone or tablet.
- Step 2:** Choose a locomotive to operate on DCC and instal the appropriate decoder.
- Step 3:** Link the locomotive to the smart device which has the HM|DC app already installed.
- Step 4:** Fit DCC clips to all points and remove all non DCC fitted locomotives from the layout.
- Step 5:** Using the HM|DC app, slide acceleration control should be moved to full power.
- Step 6:** Switch to the HM|DCC app and the HM7000 fitted locomotive can now be operated.

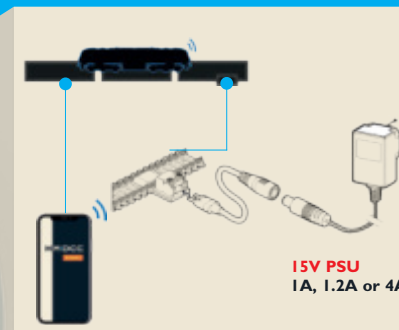

HM7000 HM|DCC

For those who are just starting in modelling railways and wish to control their layout using the HM7000 HM|DCC control system, installation and operation could not be simpler

As with other connections, the HM7000 app will need to be downloaded on to a preferred smart device. The chosen locomotive or locomotives will each require the fitting of a suitable Hornby Bluetooth® enabled decoder. Power to the track can be via a suitable Hornby 1A, 1.2A or 4A transformer. To link the transformer to the Hornby Power Track it is necessary to connect in line between the transformer and the track an HM7020 Power Supply Adapter Harness. Once power is connected it is then possible to link the Hornby Bluetooth® enabled locomotives to the smart device and operations can begin.



DCC Upgrade using Hornby HM7000 HM|DCC control

For those who are already operating their layout using DCC it is possible to have the benefits of operating some of their trains with the Bluetooth® protocol using the HM|DCC app. To do this it is required for the HM|DCC app to be downloaded to a selected smart device, either 'phone or tablet. Next, locomotives must be fitted with a suitable Hornby Bluetooth® enabled decoder and paired with the smart device. Once this process is completed those models can now be controlled using the smart device. All other locomotives can be controlled using the existing DCC unit only.

Similarly, it is possible for all locomotives fitted with either a Hornby HM7000 or conventional decoder to be operated using the HM|DCC Bluetooth® system via a smart device. To do this an HM7040 Legacy Dongle must be plugged into the RJ12 socket of an existing DCC Base Station, such as can be found on the Hornby 'Elite' or 'Select'.

Having connected the Legacy Dongle ALL locomotives can be controlled by either the smart device or the Base Station, however only those fitted with an HM7000 type decoder can have the CV settings changed while on the layout. All other models must have their CVs changed in the conventional way.

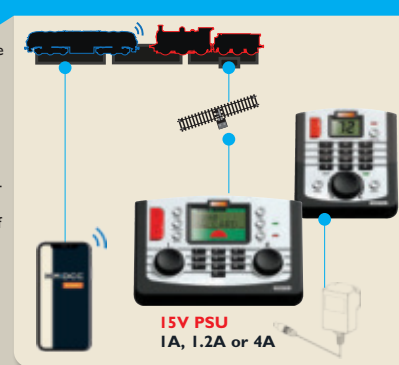

Sky's the limit...Hornby HM7000

HORNBY **HM DCC** 7000

Hornby Bluetooth decoders are fully compatible with existing Hornby DCC controllers



R7377 HM - Power Bank Pack



R7326 HM7040 Legacy Dongle for existing DCC Controllers



R7324 HM7020 PSU Solution (Harness)

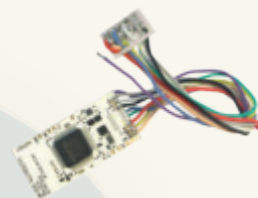

R7336 HM7000 8TXS BLE Decoder (8 Pin - TXS Sound)



R7321 HM7000 6 BLE Decoder (6 Pin - No Sound)



R7335 HM7000 8 BLE Decoder (8 Pin - No Sound)



R7322 HM7000 2ITXS - BLE Decoder (21 Pin - TXS Sound)



R7345 HM7000 NI8TXS BLE Decoder (Next18 Pin - TXS Sound)

R7327 HM7050 Reverse Loop Module

R7337 HM7020 PSU Solution (Harness) & Digital 15V 4 Amp Transformer



HM7000 Sound Downloads

- | | |
|--|---|
| SD001 Sound Download - A3 | SD019 Sound Download - Britannia |
| SD002 Sound Download - A4 | SD020 Sound Download - Merchant Navy |
| SD003 | SD021 |
| SD004 Sound Download - Class 43 MTU | SD022 Sound Download - Class 50 |
| SD005 Sound Download - Class 91 | SD023 |
| SD006 Sound Download - Class 73 | SD024 Sound Download - B12 |
| SD007 Sound Download - Class 800 | SD025 Sound Download - W1 |
| SD008 Sound Download - P2 | SD026 Sound Download - 9F |
| SD009 Sound Download - Class 08 | SD027 Sound Download - 4 VEP |
| SD010 Sound Download - Tornado | SD028 Sound Download - Class 87 |
| SD011 | SD029 Sound Download - Black 5 |
| SD012 Sound Download - Class 40 | SD030 Sound Download - Class 755 Flirt |
| SD013 Sound Download - Class 37 | SD031 Sound Download - Turbomotive |
| SD014 Sound Download - Class 71 | SD032 Sound Download - Class 55 Deltic |
| SD015 Sound Download - Class 67 | SD033 Sound Download - A1/A3, Sound Generator Fitted |
| SD016 Sound Download - Class 2P | SD034 Sound Download - P2, Sound Generator Fitted |
| SD017 Sound Download - Class 4F | SD035 Sound Download - Black 5, Sound Generator Fitted |
| SD018 Sound Download - Class 31 | |

Track & Building Extension Packs

The set track layout as shown on the MidiMats provided in most train sets can be extended in easy steps by adding Track Packs, all the way up to the full layout and beyond.

R8217 TrakMat 1800mm x 1200mm



R8227 Building Extension Pack 1

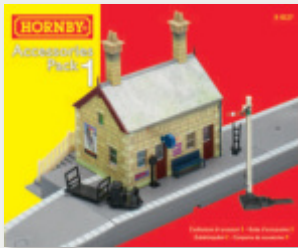

R8228 Building Extension Pack 2

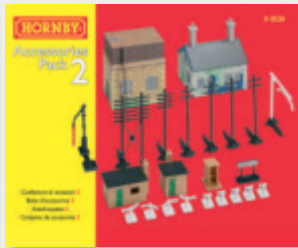

R8229 Building Extension Pack 3



R8230 Building Extension Pack 4



R8231 Building Extension Pack 5



R574 Trackside Accessories

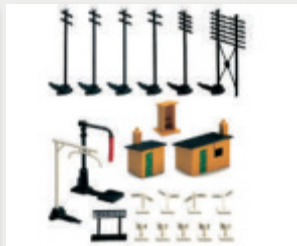

R8221 Extension Pack A



Extension Pack A
Add Extension Pack A to the Starter Oval supplied with the smaller Hornby train sets to make this layout.

R8222 Extension Pack B



Extension Pack B
Add B to the Starter Oval + A to make this layout.

R8223 Extension Pack C



Extension Pack C
Add C to the Starter Oval + A + B to make this layout.

R8224 Extension Pack D



Extension Pack D
Add D to the Starter Oval + A + B + C to make this layout. This would complete the layout on the MidiMat included in our Sets.

R8225 Extension Pack E



Extension Pack E
Add E to the Starter Oval + A + B + C + D to make this layout.

R8226 Extension Pack F



Extension Pack F
Add F to the Starter Oval + A + B + C + D + E to achieve the full TrakMat layout. Complete the scene with TrakMat Accessory Building Packs and Hornby landscaping details.

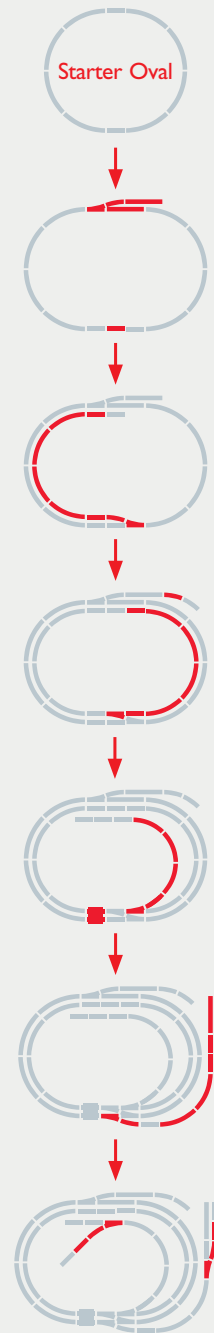

A MODEL WORLD

Buildings & Accessories

One of the most exciting parts of model railways is the planning of the layout. Will it be a country setting with rich green pastures and tree lined roads with a small village nestled around the train station, or an industrial layout with marshalling yards including a town with busy roads and an abundance of houses and shops.

Maybe it is planned for the layout to be a mixture of both with a wooded area off to one side while on another part of the layout a busy High Street with all the hustle and bustle associated with such an area. Whatever is decided much depends on the size of the layout, the demands of the modeller and their expectations.

Hornby offers a truly expansive range of buildings and scenic material that can add character and form to most layouts. For ease of construction the Hornby range of clip together buildings can be quickly and easily assembled and placed in situ in a very short space of time. Several stations from Wayside Halt to a major Station are available as are a Signal Box, Water Tower, Engine Shed and even a two lane Engine Shed, all of which are easily assembled.

For those who are looking for something a little more original than the hand painted ready made range of Skaledale resin buildings answers most needs from Stations to Shops and from houses to even a Church. Each structure is superbly hand crafted and quite frequently based on actual buildings.

For the truly admiring scenic effects of trees, hedges and ground cover (scatter) then the extensive selection from the SkaleScenic range will add surely be the answer.

R8009 Station Terminus

R590 Station Halt

R513 Platform Fencing

R8000 Country Station

R083 Buffer Stop

R394 Hydraulic Buffer Stop

R8007 Booking Hall

R8001 Waiting Room

R076 Footbridge

R510 Platform Shelter

R514 Platform Canopies (Pack of 2)

R334 Station Over-Roof (Platforms not included)

R464 Platform Ramp

R463 Curved Platform (Small Radius)

R460 Straight Platform

R462 Curved Platform (Large Radius)

R8005 Signal Box

R8003 Water Tower

R8004 Engine Shed

R8002 Goods Shed

R8006 Diesel Maintenance Depot

R530 Pylons

R645 Level Crossing, Single Track

R636 Level Crossing, Double Track

R658 Inclined Piers

R659 High Level Piers

R909 Elevated Track Support Set

R660 Elevated Track Sidewalls

R537 Lineside Fencing

R070 Motorised Turntable

R189 Brick Bridge Length 111mm

R180 Viaduct Length 332mm

R8008 Grand Suspension Bridge Length 1372mm

Elevated Track Running Length: The maximum track running length to a height of 80mm with supports at 24 sleeper intervals is approximately 1344mm. However for a more gradual incline with the supports at 30 sleeper intervals the overall running length increases to approximately 1680mm.

A MODEL WORLD

Buildings & Accessories

Model features include:

- 1:76 Scale
- Highly defined resin structures
- Detail features with hand finished embellishments
- Etched metal window frames (where appropriate)

Tunnel Portals



R8509 Single Stone Tunnel Portal x 2



R8511 Double Stone Tunnel Portal x 2



R8544 Stone Portal Side Walling



R8545 Brick Portal Side Walling



R8510 Single Brick Tunnel Portal x 2



R8512 Double Brick Tunnel Portal x 2

Brick & Stone Walling

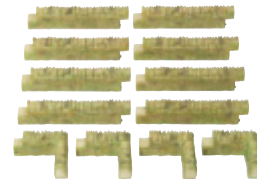

R8526 Granite Wall Pack No. 1



R8527 Granite Wall Pack No. 2

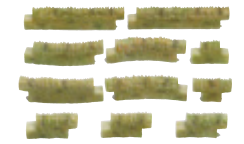

R8538 Granite Wall Pack No. 3



R8539 Cotswold Stone Pack No. 1



R8540 Cotswold Stone Pack No. 2

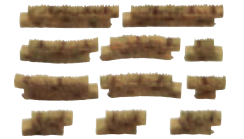

R8541 Cotswold Stone Pack No. 3



R8977 Brick Walling - Straight



R8978 Brick Walling - Corners



R8979 Brick Walling - Gates & Piers

People & Animals

Note: These images are for illustration only, colours may differ from those illustrated.



R7115 City People Pack of seven different people (male & female)



R7116 Town People Pack of eight different people (male & female, adults & children)



R7117 Working People Pack of six different people and three work items (male)



R7119 Sitting People Pack of six different people and two benches (male & female)



R7118 Farm People Pack of six different people (male & female)



R7120 Farm Animals Pack of seven different animals and four sections of fencing



R7121 Cows Pack of ten cows (two breeds)



R7122 Sheep Pack of ten sheep

Platforms & Accessories

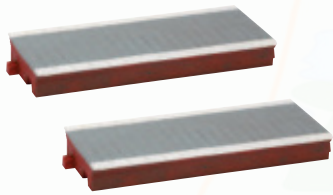

R8614 Straight Platforms x 2



R7304 Platform Island x 2

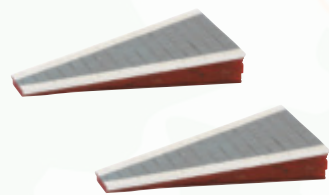

R8615 Platform Ramps x 2

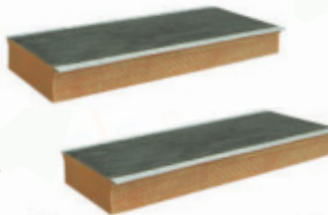

R7285 Platform Straight x 2

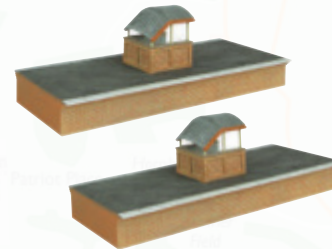

R7287 Platform Island x 2

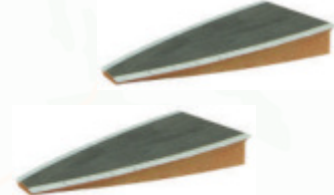

R7286 Platform Ramp x 2

R7371 Platform Steps



R7370 Platform End Ramp x 2

R8674 Bench x 2



R8673 Platform Lamps x 4

Retaining Walls & Arched Viaducts



R7373 High Level Arched Retaining Walls x 2 (Engineers Blue Brick)



R7375 High Stepped Arched Retaining Walls x 2 (Engineers Blue Brick)



R7368 Three Arch Viaduct with Lockups x 2 (Engineers Blue Brick)



R7374 High Stepped Arched Retaining Walls x 2 (Red Brick)



R7372 High Level Arched Retaining Walls x 2 (Red Brick)



R7387 Mid Stepped Arched Retaining Walls x 2 (Engineers Blue Brick)



R7389 Low Level Arched Retaining Walls x 2 (Engineers Blue Brick)



R7367 Three Arch Viaduct with Lockups x 2 (Red Brick)



R7386 Mid Stepped Arched Retaining Walls x 2 (Red Brick)



R7384 Mid Level Arched Retaining Walls x 2 (Red Brick)



R7385 Mid Level Arched Retaining Walls x 2 (Engineers Blue Brick)



R7388 Low Level Arched Retaining Walls x 2 (Red Brick)

R7390 Girder Bridge

Engineers Blue Brick

Red Brick

MAIN INDEX 2025

JOUEF	HJ4194	PAG 33	HJ6308	PAG 37	ELECTROTREN	HE6065	PAG 90
HJ2342/S	HJ4198	PAG 16	HJ6309	PAG 25	HE2010/D/S	HE6070	PAG 89
HJ2417/S	HJ4199	PAG 10-11	HJ6310	PAG 25	HE2011/D/S	HE6072	PAG 88
HJ2436/S	HJ4205	PAG 14	HJ6311	PAG 26	HE2015/S	HE6073	PAG 89
HJ2437/S	HJ4206HM	PAG 15	HJ6312	PAG 27	HE2020/D/S	HE6080	PAG 90
HJ2438/S	HJ4207	PAG 15	HJ6313	PAG 28	HE2021/D/S	HE6084	PAG 91
HJ2453/S	HJ4208	PAG 22	HJ6314	PAG 29	HE2022/D/S	HE6085	PAG 91
HJ2454/S	HJ4209	PAG 23	HJ6315	PAG 30	HE2027/D/S	HE6086	PAG 91
HJ2461/S	HJ6228	PAG 12	HJ6316	PAG 42	HE2028/D/S	ELECTROTREN HOBBY	
HJ2462/S	HJ6229	PAG 13	JOUEF LOISIRS	PAG 42	HE2029/D/S	HE2501A	PAG 104
HJ2463/S	HJ6230	PAG 13	HJ2620	PAG 43	HE2030/D/S	HE2501B	PAG 104
HJ2464/S	HJ6277	PAG 17	HJ2621	PAG 38	HE2031/D/S	HE2503	PAG 105
HJ2465/S	HJ6278	PAG 17	HJ2622	PAG 38	HE3001	HE2505	PAG 105
HJ2468/S	HJ6279	PAG 20	MKD	PAG 39	HE3002		
HJ2469/S	HJ6287	PAG 21	MKD2020	PAG 41	HE3003		
HJ2470/S	HJ6289	PAG 21	MKD2021	PAG 41	HE4027		
HJ2471/S	HJ6290	PAG 19	MKD2022	PAG 34	HE4028		
HJ2472/S	HJ6291	PAG 19	MKD2023	PAG 34	HE4037		
HJ4188	HJ6294	PAG 31		PAG 40	HE4038		
HJ4189	HJ6295	PAG 31		PAG 40	HE4042		
HJ4191	HJ6300	PAG 32		PAG 36	HE4043		
HJ4192	HJ6301	PAG 32		PAG 36	HE4044		
HJ4193	HJ6303	PAG 33		PAG 39	HE6026		PAG 88

RIVAROSSI		HR2977/HM	PAG 129	HR4408	PAG 141	HR6673	PAG 156	LIMA
HR2892/S	PAG 114	HR2979/S	PAG 132	HR4409	PAG 146	HR6674	PAG 160	HL4050 PAG 199
HR2893/S	PAG 115	HR2980/S	PAG 133	HR4416	PAG 147	HR6675	PAG 160	HL4051 PAG 199
HR2914/S	PAG 111	HR2981	PAG 140	HR4417	PAG 147	HR6676	PAG 162	LIMA / JOUEF
HR2915/S	PAG 112	HR2982/S	PAG 141	HR4418	PAG 148	HR6677	PAG 162	HC5000 PAG 200
HR2916/S	PAG 1113	HR2988/S	PAG 122	HR4419	PAG 148	HR6678	PAG 163	HC5001 PAG 200
HR2923/S	PAG 126	HR2989/S	PAG 123	HR4420	PAG 152	HR6679	PAG 163	HC5002 PAG 200
HR2924/S	PAG 127	HR2990/D/S	PAG 120	HR4421	PAG 152	HR6680	PAG 164	HC5003 PAG 200
HR2925/D/S	PAG 121	HR3024	PAG 137	HR6546	PAG 161	HR6681	PAG 164	
HR2941/S	PAG 134	HR3025	PAG 139	HR6547	PAG 161	HR6684	PAG 164	
HR2942/S	PAG 134	HR3026	PAG 139	HR6565	PAG 158	LIMA EXPERT		
HR2953/S	PAG 117	HR4348	PAG 150	HR6566	PAG 159	HL1750	PAG 190	
HR2954/S	PAG 119	HR4349	PAG 149	HR6567	PAG 159	HL1751	PAG 192	
HR2955/S	PAG 119	HR4350	PAG 150	HR6643	PAG 153	HL2656	PAG 196	
HR2961/S	PAG 135	HR4373	PAG 151	HR6644	PAG 153	HL2663	PAG 194	
HR2962/S	PAG 137	HR4377	PAG 149	HR6649	PAG 157	HL2664	PAG 195	
HR2963/S	PAG 139	HR4381	PAG 152	HR6650	PAG 157	HL2667	PAG 197	
HR2964/S	PAG 139	HR4389	PAG 144	HR6651	PAG 158	HL4674	PAG 191	
HR2965/S	PAG 130	HR4390	PAG 143	HR6666	PAG 154	HL4675	PAG 193	
HR2966/S	PAG 130	HR4391	PAG 143	HR6667	PAG 154	HL4677	PAG 191	
HR2967/S	PAG 131	HR4395	PAG 145	HR6670	PAG 155	HL4678	PAG 193	
HR2968/S	PAG 131	HR4397	PAG 145	HR6671	PAG 155	HL5057	PAG 198	
HR2972/S	PAG 125	HR4407	PAG 141	HR6672	PAG 156	HL5058	PAG 198	

DIORAMA ACCESSORIES		HORNBY ACCESSORIES		R169	PAG 211	R604	PAG 210	R660	PAG 217
HC8021	PAG 202	HC8006	PAG 208	R170	PAG 211	R605	PAG 210	R7115	PAG 218
HC8023	PAG 202	HC8007	PAG 208	R171	PAG 211	R606	PAG 210	R7116	PAG 218
HC8059	PAG 203	HC8034	PAG 208	R172	PAG 211	R607	PAG 210	R7117	PAG 218
HC8060	PAG 203	HC8035	PAG 209	R180	PAG 217	R608	PAG 210	R7118	PAG 218
HC8061	PAG 203	HC8036	PAG 209	R189	PAG 217	R609	PAG 210	R7119	PAG 218
HC8062	PAG 203	HC8037A	PAG 209	R207	PAG 211	R610	PAG 210	R7120	PAG 218
HC8065	PAG 203	HC8038	PAG 209	R394	PAG 217	R614	PAG 210	R7121	PAG 218
HEICO		HC8039A	PAG 209	R406	PAG 211	R615	PAG 210	R7122	PAG 218
HC2100	PAG 205	TRACKS, POWER AND ACCESSORIES		R460	PAG 217	R617	PAG 211	R7150	PAG 212
HC2103	PAG 205	HT8300	PAG 213	R462	PAG 217	R618	PAG 210	R7200	PAG 211
HC2104	PAG 204	HT8301	PAG 213	R463	PAG 217	R619	PAG 210	R7229	PAG 211
SPARE PARTS		HT8302	PAG 213	R464	PAG 217	R620	PAG 211	R7274	PAG 212
HC6100	PAG 206	HT8304	PAG 213	R513	PAG 217	R621	PAG 210	R7285	PAG 219
HC6101	PAG 206	P9001	PAG 211	R530	PAG 217	R626	PAG 211	R7286	PAG 219
HC6102	PAG 206	P9100	PAG 211	R537	PAG 217	R628	PAG 210	R7287	PAG 219
HC6103	PAG 206	R044	PAG 211	R574	PAG 217	R636	PAG 217	R7292	PAG 213
HC6104	PAG 206	R046	PAG 211	R590	PAG 217	R638	PAG 211	R7293	PAG 213
HC6105	PAG 206	R047	PAG 211	R600	PAG 210	R643	PAG 210	R7304	PAG 219
HC8040	PAG 207	R070	PAG 217	R601	PAG 210	R645	PAG 217	R7305	PAG 212
		R076	PAG 217	R602	PAG 211	R658	PAG 217	R7321	PAG 215
		R083	PAG 217	R603	PAG 210	R659	PAG 217	R7322	PAG 215

R7324	PAG 215	R7389	PAG 219	R8075	PAG 210	R8224	PAG 216	R8511	PAG 218
R7326	PAG 215	R7390	PAG 219	R8076	PAG 210	R8225	PAG 216	R8512	PAG 218
R7327	PAG 215	R7398	PAG 211	R8077	PAG 210	R8226	PAG 216	R8526	PAG 218
R7335	PAG 215	R7399	PAG 211	R8078	PAG 210	R8227	PAG 216	R8527	PAG 218
R7336	PAG 215	R7400	PAG 211	R8087	PAG 210	R8228	PAG 216	R8538	PAG 218
R7337	PAG 215	R7401	PAG 212	R8090	PAG 210	R8229	PAG 216	R8539	PAG 218
R7338	PAG 212	R7402	PAG 212	R8096	PAG 211	R8230	PAG 216	R8540	PAG 218
R7345	PAG 215	R8000	PAG 217	R8097	PAG 211	R8231	PAG 216	R8541	PAG 218
R7367	PAG 219	R8001	PAG 217	R8098	PAG 211	R8232	PAG 212	R8544	PAG 218
R7368	PAG 219	R8002	PAG 217	R8099	PAG 211	R8234	PAG 211	R8545	PAG 218
R7370	PAG 219	R8003	PAG 217	R8100	PAG 211	R8241	PAG 212	R8614	PAG 219
R7371	PAG 219	R8004	PAG 217	R8201	PAG 211	R8242	PAG 212	R8615	PAG 219
R7372	PAG 218	R8005	PAG 217	R8206	PAG 211	R8243	PAG 211	R8673	PAG 219
R7373	PAG 218	R8006	PAG 217	R8211	PAG 211	R8244	PAG 211	R8674	PAG 219
R7374	PAG 219	R8007	PAG 217	R8213	PAG 212	R8247	PAG 212	R8977	PAG 218
R7375	PAG 218	R8008	PAG 217	R8214	PAG 212	R8249	PAG 212	R8978	PAG 218
R7377	PAG 215	R8009	PAG 217	R8217	PAG 216	R8261	PAG 210	R8979	PAG 218
R7382	PAG 212	R8012	PAG 211	R8218	PAG 211	R8262	PAG 210	R909	PAG 217
R7384	PAG 219	R8014	PAG 211	R8219	PAG 211	R8264	PAG 211	R910	PAG 211
R7385	PAG 219	R8015	PAG 211	R8220	PAG 211	R8267	PAG 211	R913	PAG 211
R7386	PAG 219	R8072	PAG 210	R8221	PAG 216	R8268	PAG 211	R920	PAG 211
R7387	PAG 219	R8073	PAG 210	R8222	PAG 216	R8509	PAG 218		
R7388	PAG 219	R8074	PAG 210	R8223	PAG 216	R8510	PAG 218		

STILL AVAILABLE INDEX 2025

JOUEF		HJ2450/S	PAG 52	HJ6247	PAG 56	ELECTROTREN		HE4030	PAG 98
HJ1062	PAG 57	HJ2452/S	PAG 52	HJ6248	PAG 56	HE2006/D	PAG 93	HE4031	PAG 99
HJ2403	PAG 47	HJ2458/S	PAG 52	HJ6249	PAG 56	HE2008	PAG 93	HE4032	PAG 99
HJ2415/S	PAG 47	HJ2459/S	PAG 52	HJ6250	PAG 56	HE2009	PAG 93	HE4033	PAG 99
HJ2416/S	PAG 47	HJ2460/S	PAG 52	HJ6252	PAG 56	HE2012	PAG 94	HE4035	PAG 99
HJ2418/S	PAG 48	HJ3014	PAG 50	HJ6254	PAG 55	HE2013	PAG 94	HE4036	PAG 99
HJ2419/S	PAG 48	HJ3015	PAG 50	HJ6260	PAG 57	HE2014	PAG 94	HE6009	PAG 100
HJ2420/S	PAG 48	HJ4174	PAG 53	HJ6261	PAG 57	HE2016	PAG 94	HE6022	PAG 100
HJ2425/S	PAG 50	HJ4175	PAG 53	HJ6264	PAG 57	HE2017/S	PAG 94	HE6024	PAG 100
HJ2429/S	PAG 48	HJ4176	PAG 53	HJ6267	PAG 57	HE2018/S	PAG 95	HE6051	PAG 100
HJ2430	PAG 49	HJ4177	PAG 53	HJ6272	PAG 57	HE2019/S	PAG 95	HE6052	PAG 100
HJ2431	PAG 49	HJ4178	PAG 53	HJ6281	PAG 57	HE2023/S	PAG 96	HE6061	PAG 100
HJ2432	PAG 49	HJ4179	PAG 53	HJ6292	PAG 57	HE2024/S	PAG 96	HE6062	PAG 101
HJ2433	PAG 49	HJ4181	PAG 54	HJ6293	PAG 57	HE2025/S	PAG 96	HE6063	PAG 101
HJ2440/S	PAG 50	HJ4182	PAG 54	JOUEF LOISIRS		HE4001	PAG 97	HE6064	PAG 101
HJ2441/S	PAG 50	HJ4183	PAG 54	HJ2613	PAG 62	HE4013	PAG 97	HE6068	PAG 101
HJ2442/S	PAG 50	HJ4184	PAG 54	HJ2614	PAG 62	HR4015	PAG 97	HE6071	PAG 101
HJ2443/S	PAG 51	HJ4185	PAG 54	HJ2615	PAG 62	HE4018	PAG 97	ELECTROTREN HOBBY	
HJ2444/S	PAG 51	HJ4186	PAG 54	HJ2616	PAG 63	HE4020	PAG 97	HE2500A	PAG 106
HJ2445/S	PAG 51	HJ4196	PAG 55	HJ2617	PAG 63	HE4021	PAG 97	HE2500B	PAG 107
HJ2446/S	PAG 51	HJ4197	PAG 55	HJ2619	PAG 63	HE4022	PAG 98	HE2502A	PAG 106
HJ2447/S	PAG 51	HJ4200	PAG 55			HE4024	PAG 98	HE2502B	PAG 107
HJ2449/S	PAG 51	HJ6239	PAG 56			HE4029	PAG 98	HE2504A	PAG 106

RIVAROSSI		HR2920/S	PAG 169	HR2960/S	PAG 173	HR4374	PAG 179	HR6589	PAG 183
HR2789/S	PAG 165	HR2921/S	PAG 169	HR2969/S	PAG 174	HR4375	PAG 179	HR6590	PAG 183
HR2807	PAG 165	HR2928/S	PAG 170	HR2970/D	PAG 174	HR4376	PAG 179	HR6591	PAG 183
HR2808/S	PAG 165	HR2929/S	PAG 170	HR2971/D	PAG 174	HR4378	PAG 179	HR6592	PAG 18
HR2809	PAG 165	HR2930/S	PAG 170	HR4324	PAG 175	HR4392	PAG 180	HR6598	PAG 183
HR2810	PAG 165	HR2931/S	PAG 170	HR4326	PAG 175	HR4393	PAG 180	HR6599	PAG 183
HR2854/S	PAG 166	HR2932/S	PAG 170	HR4333	PAG 175	HR4394	PAG 180	HR6600	PAG 184
HR2855/S	PAG 166	HR2933/S	PAG 170	HR4334	PAG 175	HR4382	PAG 180	HR6601	PAG 184
HR2861HM	PAG 166	HR2934/S	PAG 171	HR4351	PAG 175	HR4383	PAG 181	HR6602	PAG 184
HR2889/ACS/S	PAG 166	HR2935/S	PAG 171	HR4354	PAG 175	HR4399	PAG 180	HR6603	PAG 184
HR2890/S	PAG 166	HR2936S	PAG 171	HR4355	PAG 176	HR4400	PAG 180	HR6604	PAG 184
HR2891/ACS/S	PAG 166	HR2938/S	PAG 171	HR4358	PAG 176	HR6520	PAG 181	HR6605	PAG 184
HR2897/S	PAG 167	HR2939/S	PAG 171	HR4359	PAG 176	HR6552	PAG 181	HR6607	PAG 185
HR2898/S	PAG 167	HR2940/S	PAG 171	HR4360	PAG 177	HR6553	PAG 181	HR6608	PAG 185
HR2900/S	PAG 167	HR2943/HM	PAG 172	HR4361	PAG 176	HR6555	PAG 181	HR6609	PAG 185
HR2904/S	PAG 167	HR2945HM	PAG 172	HR4362	PAG 176	HR6558	PAG 181	HR6612	PAG 185
HR2905/S	PAG 167	HR2950	PAG 188	HR4365	PAG 178	HR6561	PAG 181	HR6614	PAG 185
HR2909/S	PAG 168	HR2951	PAG 188	HR4366	PAG 178	HR6562	PAG 182	HR6615	PAG 185
HR2910/S	PAG 168	HR2952	PAG 188	HR4367	PAG 178	HR6569	PAG 182	HR6616	PAG 186
HR2912/D/S	PAG 168	HR2956/S	PAG 172	HR4368	PAG 178	HR6570	PAG 182	HR6617	PAG 186
HR2913/D/S	PAG 168	HR2957/S	PAG 172	HR4369	PAG 178	HR6573	PAG 182	HR6618	PAG 186
HR2917/S	PAG 169	HR2958ACS/S	PAG 173	HR4370	PAG 178	HR6574	PAG 182	HR6619	PAG 186
HR2918/S	PAG 169	HR2959/S	PAG 173	HR4371	PAG 180	HR6576	PAG 182	HR6620	PAG 186

HR6621	PAG 186	HR6665C	PAG 188
HR6622	PAG 187	HR6665D	PAG 188
HR6625	PAG 187		
HR6645	PAG 187		
HR6647	PAG 187		
HR6661A	PAG 188		
HR6661B	PAG 188		
HR6661C	PAG 188		
HR6661D	PAG 188		
HR6662A	PAG 188		
HR6662B	PAG 188		
HR6662C	PAG 188		
HR6662D	PAG 188		
HR6663A	PAG 188		
HR6663B	PAG 188		
HR6663C	PAG 188		
HR6663D	PAG 188		
HR6664A	PAG 188		
HR6664B	PAG 188		
HR6664C	PAG 188		
HR6664D	PAG 188		
HR6665A	PAG 188		
HR6665B	PAG 188		

All rights reserved.
Reproduction, even partial, is prohibited.
© Copyright Hornby Hobbies Ltd.

Produced and printed in Italy





©Hornby Hobbies Ltd.

HORNBY HOBBIES LTD

Westwood, Margate, Kent, CT9 4JX, UK

EU Authorised Representative:

Hornby Italia SRL
Viale dei Caduti, 52/A6, Castel Mella
(BS), Italy, 25030

www.jouef.com
www.electrotren.com
www.rivarossi.com
www.limamodel.com



/JOUEF
/Electrotren
/rivarossi.model
/lima.models



@hornbyinternational

DE

08000.00.26.27

Customerservices.de@hornby.com
Technicalservices.de@hornby.com

ES

900.67.03.41

Customerservices.es@hornby.com
Technicalservices.es@hornby.com

FR

801.87.00.06

Customerservices.fr@hornby.com
Technicalservices.fr@hornby.com

IT

800.01.98.50

Customerservices.it@hornby.com
Technicalservices.it@hornby.com

UK

+44(0)1843 233525

Customerservices.uk@hornby.com
Technicalservices.uk@hornby.com



HP2025H0